

# IDEAS

Inventing, Designing, and Engineering for All Students

**MAKER PROGRAM**

## World-Building Curriculum Facilitator Guide

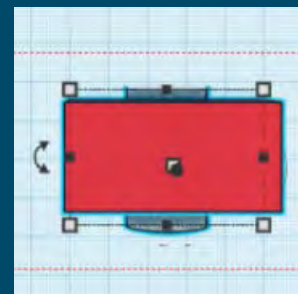
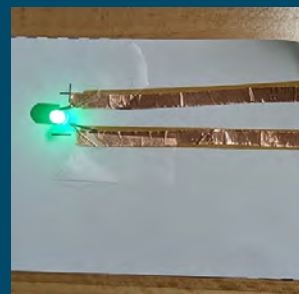
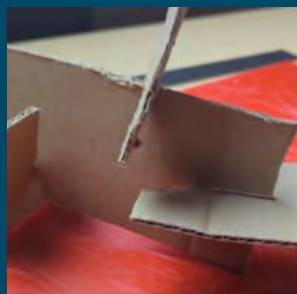
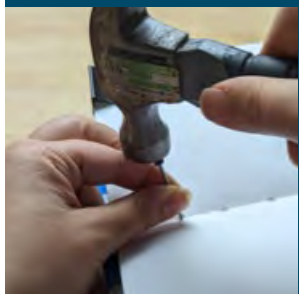



New York Hall of Science



This material is based on work supported by the National Science Foundation under Grant #DRL1850289. Any opinions, findings, and conclusions or recommendations expressed in this material are those of the authors and do not necessarily reflect the views of the National Science Foundation.

# Table of Contents

<b>Curriculum Introduction</b>	<b>4</b>
<b>Curriculum Overview</b>	<b>8</b>
<b>Introduction: Making Is a Process</b>	<b>14</b>
<b>Activity 1: Imagine a World</b>	<b>19</b>
<b>Activity 2: Make a Journal</b>	<b>27</b>
<b>Activity 3: Work with Clay</b>	<b>47</b>
<b>Activity 4: Work with Cardboard</b>	<b>58</b>
<b>Activity 5: Build with Blocks</b>	<b>75</b>
<b>Activity 6: Light Up an LED</b>	<b>83</b>
<b>Activity 7: Make a Light-Up Sign</b>	<b>96</b>
<b>Activity 8: Make an Object Move</b>	<b>105</b>
<b>Activity 9: Make a Virtual Object</b>	<b>114</b>
<b>Activity 10: Refine and Finish Worlds</b>	<b>133</b>
<b>Conclusion: Host a Showcase</b>	<b>138</b>
<b>Appendix</b>	<b>141</b>

# Curriculum Introduction

## Why Make?

Children’s seminal learning experiences come through direct engagement with materials. You need only watch a toddler play with blocks to know how true this is. This idea is also reflected in Piaget’s theory of constructivism: People construct new knowledge by combining novel experiences with what they already know.

## Curriculum Summary

This curriculum challenges students to create a unique world that stems from their own interests and they are excited to produce. Their world can be true to life, imaginary, or a combination of both. Students will make the objects that comprise that world as they learn how to work with a variety of tools and materials. Their experience culminates in a showcase where students can share their process and final products with their community.

## The Engineering Design Process

This curriculum presents the Engineering Design Process (EDP) as a way to think about the creative cycle. This framework is cyclical; the EDP can help makers become more aware of their unconscious creative process. This graphic of the EDP can be helpful when students are feeling stuck—seeing and naming where one is in the process fosters a mindset that *making is ongoing and recursive*.

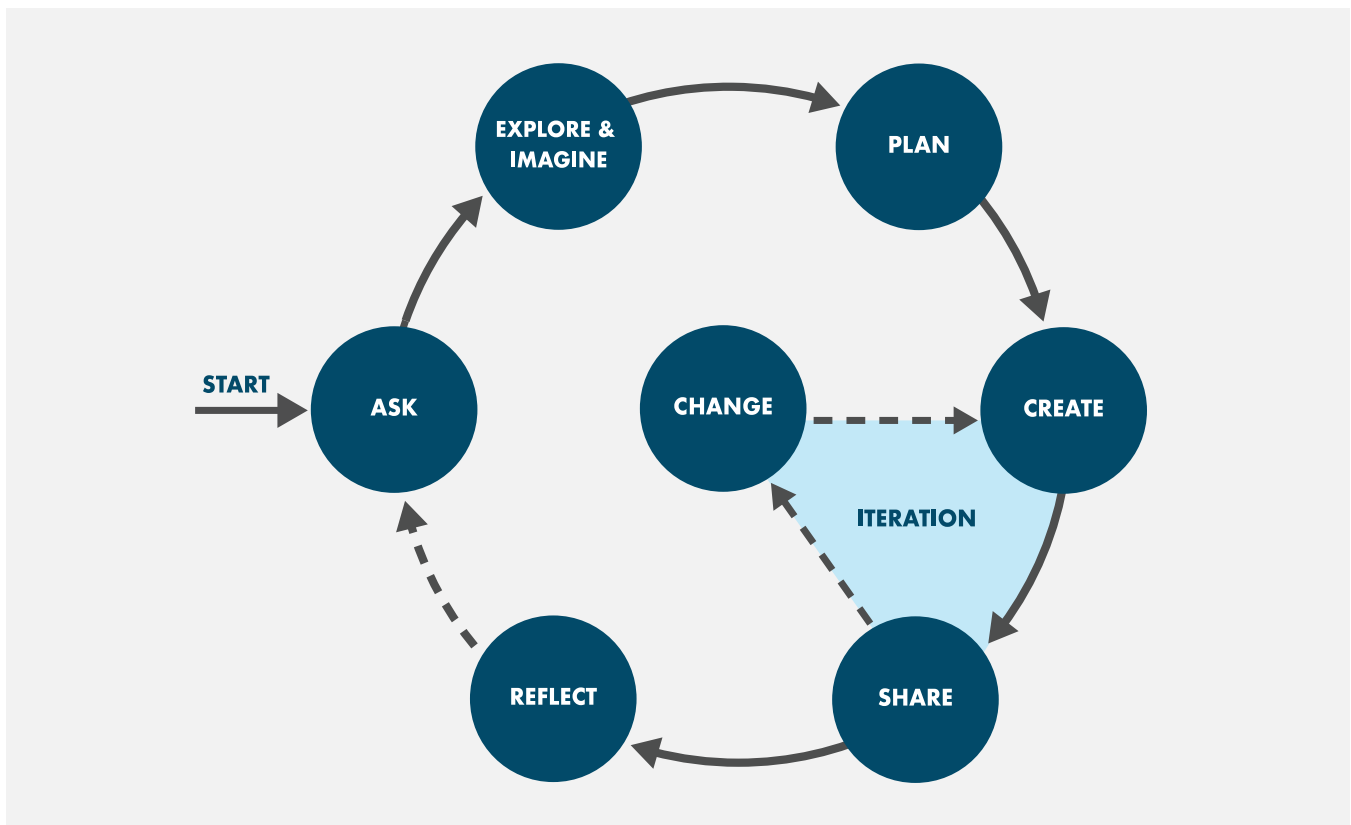

# Some Big Ideas

## Neurodiversity and Making

Maker programs give participants the time, space, and materials to pursue their ideas in innovative ways. Such openness can benefit all kinds of learners, but it can be especially beneficial for people on the autism spectrum, or those with ADD, ADHD, dyslexia, dysgraphia, and other learning differences. So much of our educational system is designed to take many students through the same content as quickly and efficiently as possible. This often means that learning differences are treated as problems and that personal interests are seen as distractions. In the world of making, divergent thinking is valued, and focused interests are assets. Maker programs like this one, which was developed with youth and educators in autism inclusion settings, can provide neurodivergent learners with the opportunity to shine and allow facilitators and peers to celebrate and learn from their strengths.

## Materials Fluency

Makers need tools and materials. *Materials fluency*—knowing the right tool for the job and using it well—is key for any maker, but especially so for novices. One of the goals for designing rich and approachable making tasks is to help students develop their materials fluency so they can enjoy being, and flourish as, makers and can push themselves to successfully make and share unique, complex, and creative representations of themselves and their ideas. The fluency they develop now will serve them for a long time to come.

## Your Role

**“It took me some time to be okay with not having an idea right away or not knowing what to do next, similar to what my students experience.”**

—Marina Pertsovky-Gonzalez, teacher

Reading through this curriculum may feel intimidating. You may hear yourself thinking things like *I don't sew!* or *What? Make a light-up sign with an LED?* Some of us worry when we are required to lead without expertise. But remember, jumping in and trying something new is exactly what we ask of our students—and we assure them that not only will they succeed, but they'll also find joy in learning. This is our message to you, too.

Take off your teacher hat and put on your learner hat. Throw out the notion that you must “work ahead” of your students, and instead leverage the enthusiasm and curiosity from those around you to solve challenges together. Enjoy the process of building and being part of a community of learners. You will quickly understand through experience that we learn how to do more things by trying to do them alongside others.

You may also wonder how you will manage a program made up of students with different skills and abilities who are working on unique projects. You may not see it this way yet, but you have a roomful of potential experts who are ready and willing to help you and one another. Encourage students to move about the room, consult with one another, look at other students' projects and ask them questions about it, and share or try out their discoveries. There is no such thing as cheating in making!

As students get going with their projects, they become deeply immersed as they create tangible versions of the ideas in their heads. They will discover favorite tools, learn more about how different materials behave, and increase their patience with troubleshooting creations that don't "work" the way they want them to at first.

## Do the Activities

Try the activities yourself. There are SO many good reasons for this—and none are about becoming an expert.

- › You'll have fun learning new stuff. Really!
- › Many activities ask you to create a sample to share with the class. Even if a sample isn't required, students will benefit from and enjoy examining a version you created. In addition, making a sample allows you to experience the feelings, failures, and successes your students may have as they navigate the activity. Sharing your process with them is one way to model a growth mindset!
- › You'll be better equipped to adapt each activity to the needs and abilities of your students.
- › You'll better understand how the tools and materials work.
- › Sharing the challenges you encountered and inviting students to troubleshoot with you fosters their own sense of confidence and expertise.



## Ask Questions

This program prioritizes asking questions over providing answers. Rather than offer suggestions on how you might “fix” a project that “isn’t working” (according to either a student’s standards or what you notice), keep the learner in the driver’s seat by asking open-ended questions, such as:

- › How’s it going?
- › What are you trying to figure out?
- › What are you thinking of trying next?

This approach has two key benefits: It models how to manage mistakes and challenges in a productive way, and it provides a chance for you to learn alongside your students.

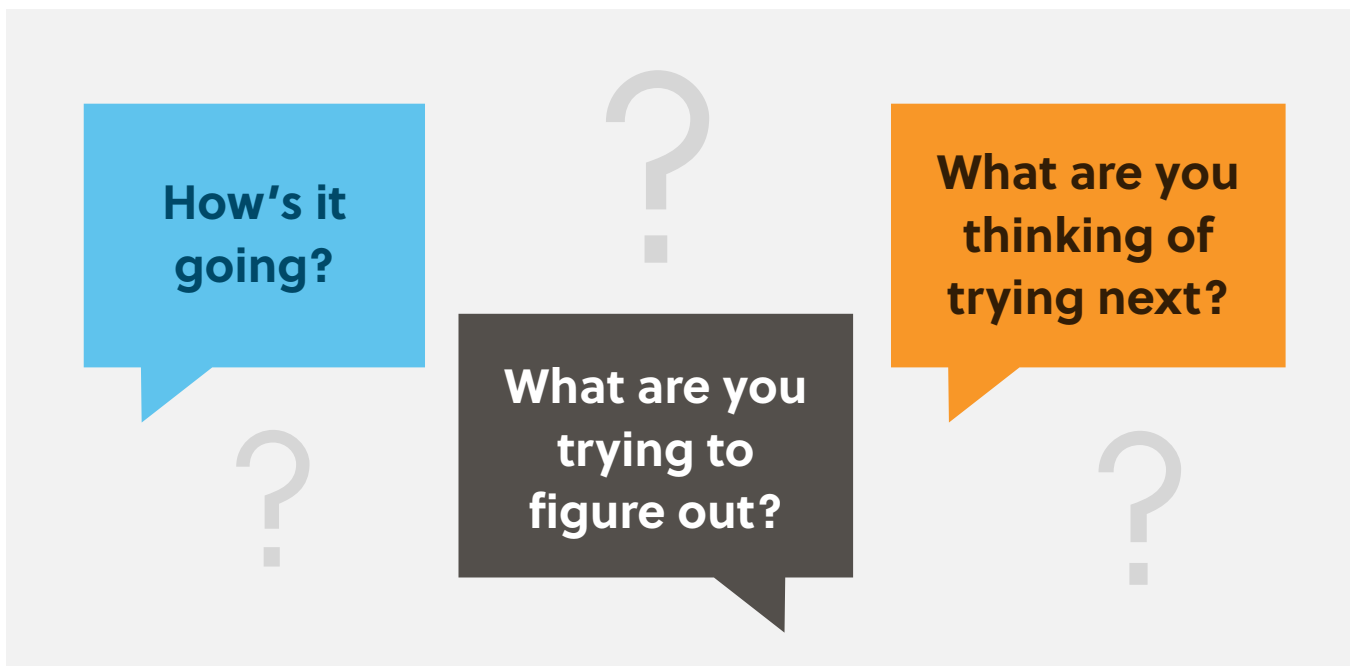

## Activity Sequence

This curriculum begins with an open-ended design challenge and introduces students to the Engineering Design Process. The 10 activities that follow are flexible, and completing all of them, or even starting with Activity 1, is not essential to creating a vibrant world. Revising or eliminating individual sessions to fit your context is encouraged! The curriculum ends with a celebration, where students share their work with the community.

It is important that YOU try the activities yourself. Not only will putting yourself in the learner's shoes help you develop the making skills to support your students, it will also help you determine how to adapt the sessions to meet your students where they are. Some helpful details:

- › **Activities 1–5** use everyday craft and household materials and will yield imagination-rich worlds that students will be proud to share with others. These activities are easily adaptable and can challenge all elementary- and middle-grades students.
- › **Activities 6–8** incorporate such materials as LEDs, batteries, and motors. Students at both the elementary and the middle grades will be delighted to use, and find success with, these slightly more advanced materials.
- › **Activity 9** uses Tinkercad, a free, online 3D modeling software. Users can create virtual objects and export a file of the virtual object to print on a 3D printer. Although not required, if a 3D printer is available, and there is a knowledgeable point person to support the use of the equipment, it's a great activity extension, allowing students to include a printed object in the world display. This activity is best suited for upper elementary- and middle-grades students, who will learn a range of advanced skills.
- › **Activity 10** (and as many subsequent sessions as you choose to offer), ensures time for students to complete their world as they use all the materials and tools they've become familiar with over the course of the curriculum.
- › The **Conclusion** is a showcase in which students share what they've created with the public. Learning how to talk about their creative process to others and think on their feet as they answer questions about their work are key aspects of fostering students' confidence and competence.

## Appendix

The Appendix includes a variety of key materials to support your use of this curriculum, for example:

- › A **Materials List**
- › A **family permission letter** explaining the program and asking parents or guardians permission for their student to use hand tools as part of the program



- › **Flyers** to support collecting recyclables for the program
- › **Graphic organizers** to support students as they develop their ideas

The Appendix also includes two resources that were designed with both neurodiverse and neurotypical learners in mind:

- › **Activity Primers** explain the activities and tools to be used in the next session. They also give students and families a heads-up about possible sensory challenges in upcoming activities.
- › **Visual Guides** are step-by-step image and text guides for all activities that require a tool. They can be given to students who are interested in working without direct teacher guidance (and able to do so) or used to help students remember what to do when they go about making on their own.

Both guides can be helpful for students, families, and teachers alike and can be distributed digitally and/or printed depending on the needs and interests of those you work with.

## Facilitator Presentation

This curriculum includes a **presentation** to help explain concepts, clarify making processes, and aid you in supporting your students through this making experience. This guide includes thumbnails of the presentation for your reference.

## Curriculum Features

### Customization

This curriculum embeds several features designed to help you customize activities for multiple learners, including those on the autism spectrum:

- › **Adjust and Scale** offers ways to extend and/or simplify a concept, activity, or making process.
- › **Sticky Spot** provides a heads-up for particular areas where students may experience higher levels of frustration with a material or process and offers suggestions for supporting students through these tough spots.
- › **Making More** suggests additional or extension options for students who are interested in further exploring a material or idea.

## Challenge Levels and Persistence

Each activity notes a “challenge level,” which is indicated by up to five stars beside the title of each session. The more stars, the more challenging. The level is determined by the degree of assumed familiarity with the materials and the ease with which a beginner maker can find “success” in using them. These levels offer information for you to consider as you plan for, or present, the activity.

Remind students that some skills and projects take longer to develop than others. Support students in being patient with themselves and suggest ways to persist through hard work, such as taking breaks, getting a drink of water, talking ideas out with a friend, or finding a partner with whom to muddle through a challenging moment.

## Time

The time needed to complete an activity can vary widely depending on the ages and interests of the students, the extent to which each activity is implemented, facilitators’ comfort with the activities, the context in which the activity is being implemented, and other factors. You will get a sense of the amount of time activities require as you try them out before facilitating them with students and can decide on the best ways to adapt them for your students.

The last slide of the [presentation](#) has a collection of digital timers for you to use during sessions.

## Materials

The [Materials List](#) in the [Appendix](#) includes everything you’ll need to run a club for approximately 15–20 students. As you read through the Materials List, you will likely discover you have access to several items already, such as pencils, markers, construction paper, paint and brushes, different kinds of tape, or other basic office and craft supplies. The Materials List also includes a supplementary list of consumable items that can be collected from families and the community.

### Optional equipment you might consider:

- › **Document camera:** Most sessions include a demonstration of some kind. If you have a document camera, laptop, and screen, make use of this setup! It’s perfect for allowing everyone to see small handwork—for example, you threading a needle.
- › **3D printer:** Activity 9 introduces Tinkercad, a free 3D modeling software that allows users to print a physical object from a virtual design. If you have access to a 3D printer but are new to this equipment, get an orientation from a colleague who’s familiar with it. Since there is a bit of a learning curve when it comes to troubleshooting 3D printing challenges, find an ally and learn together!

## Physical Space

You'll find it helpful to set up some specific areas in your room:

- › **Demonstration table:** Many sessions ask that the facilitator demonstrate a skill or process. Consider designating a spot in the room for students to gather and watch or participate in skill or process demonstrations.
- › **Supply table:** It's equally helpful to have a surface designated as a supply table. Depending on the ages and abilities of your students, having materials sorted, stacked, and ready to go in advance frees up some of your in-session time and promotes independence in the makerspace.
- › **Work areas:** Students will need space to work and create. Depending on the age and abilities of the makers you work with, individual desks, communal tables, and the floor can all be good options.
- › **Hot glue station:** Designate a spot in the room for using a hot glue gun. Depending on the ages and abilities of your students, this station may require supervision. Hot glue guns can be formally introduced in Activity 5: Build with Blocks, but it can be useful to have them heated up and ready to go for any session. Be sure to place each gun on a piece of cardboard to catch drips of hot glue.

## Storage

There are two storage needs to consider. First, you'll need a place to store the maker supplies you collect or purchase. For some, this is a closet in a hallway. For others, this is an open space under a table. Either way, having bins or sturdy copy paper boxes is useful. Storage bins or boxes with lids are ideal so you can stack them.

You'll also need a place to store student projects as they work on them. Asking colleagues or students to bring in cardboard boxes or several shoe boxes can do the trick. Maybe you can find some empty shelves where students can store in-process projects. If there is a space where students can safely leave in-process work that is easily accessible to them when they return, definitely use it. It will create less set-up time for you and will allow students to get right to work!

There's no perfect, and certainly no universal, solution, so be ready to struggle with this a bit. Even in the most perfectly designed space, there's always a need for more storage, so the creative and flexible parts of your brain will be in demand.

## Getting Organized

Each activity requires a variety of materials. You can refer to the Materials List which includes a tab that lists what is needed for each activity, along with a list of materials that are often needed in all activities. Using that tab, consider sorting two activities-worth of materials in a clear bin so you can see, and easily transport, the supplies students will need. The Materials List provides a link to a clear bin you can consider purchasing for this purpose.

## The Activities

**Introduction: Making Is a Process:** This short activity introduces students to the Engineering Design Process—a framework for understanding and describing the creative process—through a design challenge.

**Activity 1: Imagine a World:** Students think about the settings of their personal lives or favorite stories and construct an inventory of the items that make up those worlds. Students begin to imagine additional characters, structures, and/or objects that could enhance one of those worlds.

**Activity 2: Make a Journal:** Students construct journals to collect their ideas, plans, and notes about the components of the world they want to make.

**Note:** Students will use these journals in subsequent sessions to plan for and reflect on their work and their maker experiences.

**Activity 3: Work with Clay:** Students choose a character from their world-building brainstorm and use clay and clay-sculpting tools to make a 3D version of that character.

**Activity 4: Work with Cardboard:** Students use a cardboard-cutting tool called a *canary cutter* to practice four different cardboard construction techniques to build stable, strong objects for their worlds.

**Activity 5: Build with Blocks:** Students create 3D block sculptures and make diagrams of their structures.

**Note:** In Activity 9, students explore 3D design software. Those who are curious can work to transfer these sculptures to a digital model.

**Activity 6: Light Up an LED:** Students explore simple circuits as they learn how to use a battery and copper tape to make an LED light up.

**Activity 7: Make a Light-Up Sign:** Students build on what they learned about circuits in Activity 6 to design a light-up sign to showcase the name of their world.

**Activity 8: Make an Object Move:** Students continue to explore how circuits work by using batteries and motors to create an object that moves or has a moving part.

**Activity 9: Make a Virtual Object:** Students learn introductory 3D modeling skills as they transfer their block sculptures to digital 3D models using Tinkercad, a free modeling program.

**Activity 10: Refine and Finish Worlds:** Students inventory the items they have made, select which they'd like to include in their world, determine which they'd like to refine, and decide what additional items they want to include in their world.

**Note:** The number of sessions you schedule for this work will depend on the time you have available.

**Conclusion: Host a Showcase:** Students organize their worlds for display, practice interacting with visitors, and share their creations with visitors during a public showcase.

# Introduction: Making Is a Process ★★☆☆☆

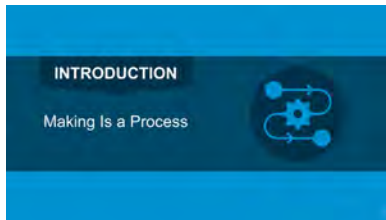

## Session Summary

---

This short activity introduces students to the Engineering Design Process—a framework for understanding and describing the creative process—through a design challenge. The challenge-level of this activity is rated two out of five stars.

## Learning Goal

---

Students understand that making is a creative, iterative process.

## Key Vocabulary

---

- › Engineering Design Process
- › Maker

## Materials

---

General Supplies	For Each Pair or Group
Yardstick	40 clothespins Bag

## Prep

---

- › Depending on the size of your group, decide whether to have students work in pairs or small groups.
- › Fill a bag with 40 clothespins for each pair or group.

## Activity Breakdown

---

- › **PART 1:** Welcome
- › **PART 2:** Design Challenge
- › **PART 3:** The Engineering Design Process (EDP)
- › **PART 4:** Reflect
- › **PART 5:** Preview Next Activity

## PART 1: Welcome

---

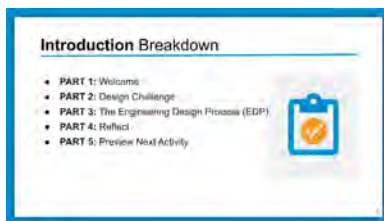

1. Welcome students to Maker Club.
2. Review the session breakdown.
3. Explain that in today's session, students will:
  - › First, try their hand at a building challenge.
  - › Next, learn about the Engineering Design Process.
  - › Hear about what they'll make in Maker Club!

## PART 2: Design Challenge

---



1. Announce that the session will start with a challenge to create a tall tower out of clothespins.



## ADJUST AND SCALE

If your students are interested in competing, you can also set up this challenge as a contest to see which group can create the tallest tower.

2. Show students how a clothespin works.



## ADJUST AND SCALE

Depending on students' ages and abilities, clothespins may be hard to open, so opening with a competitive challenge may not be ideal. Give students time to play with clothespins without the pressure of a challenge. Having time to discover what is possible with this material is equally valuable and can yield rich and interesting reflective conversations.

3. Divide students into groups or pairs, distribute bags of clothespins, and give them 15 minutes to create the tallest tower they can. Request that when you call time, students leave their towers, in whatever state they are in, intact on their work surface.
4. As students work, circulate among groups and pose open-ended questions, such as:
  - › How do clothespins work?
  - › What is your plan?
  - › Why did you choose to use the clothespins in that way?
  - › How did you decide how to start?
  - › What's the hardest part of this challenge?
  - › Can you place clothespins in ways to create curves?
5. At the end of 15 minutes, gather students, and visit each work area as a group. Ask each work team open-ended questions, such as:
  - › How did your group begin this challenge?
  - › How did you plan your tower?
  - › How did you work together?
  - › Did the tower fall down at any point? Why might that have happened? What did you do when that happened?
6. If you set up this challenge as a competition, have the class determine which tower is tallest, using the yardstick as needed. Ask:



- › What do we notice about the tallest tower?
- › How is it the same as or different from shorter towers?
- › How are the clothespins on the tallest tower arranged?
- › How did this arrangement help support the tower?

## PART 3: The Engineering Design Process (EDP)

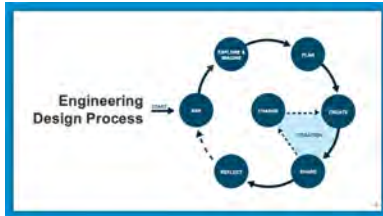

1. Bring the class back together, and show students the EDP graphic.
2. Read the steps of the cycle together. Solicit opinions about what this graphic shows. Point out that this is one way to represent the creative process. Ask students why they think the stages are shown in a circle and not in a line.
3. Ask everyone to pick a word in the cycle and then see if they can think of a moment during the tower-building challenge that fits the word. Invite students to share the connections they make.

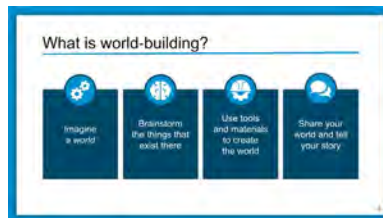

4. Tell students that over the course of the Maker Club sessions, they are going to create a world—a collection of living and non-living things that interest them—and they will learn to use different tools and materials to make that world come to life. They will go through the EDP several times as they develop their unique world. Finally, they will celebrate their creative accomplishments by inviting their community to see their world and learn how they made it.

## PART 4: Reflect

---



Have students reflect on these questions as a group, in pairs, or individually on paper in words or drawings:

- › What did you enjoy most about today's activity?
- › What are you excited about?
- › What was most challenging? How did you deal with it?
- › What did you figure out today?

## PART 5: Preview Next Activity

---



In the next activity, students begin to brainstorm ideas for a world they'd like to create. Distribute the priming document titled [Activity 1 Primer](#), found in the Appendix.

# Activity 1: Imagine a World ★★☆☆☆



## Session Summary

Students think about the settings of their personal lives or favorite stories and construct an inventory of the items that make up those worlds. The challenge-level of this activity is rated two out of five stars.

## Learning Goal and Maker Skills

Students learn to organize ideas into categories.

## Key Vocabulary

- › 2D
- › 3D
- › Inventory

## Materials

For the Teacher	For Each Student	General Supplies
Masking tape 3 pieces of chart paper Markers	3 pieces of colorful paper Popsicle stick Pencil	Markers Pencils Pens

## Prep

- › Use masking tape to mark off a large area on the floor roughly the shape of the room you are in.
- › Make a two-column chart on two separate pieces of paper with the headings **Living** and **Non-living**.

## Activity Breakdown

---

- › **PART 1:** Welcome and Recap
- › **PART 2:** Build a Paper World
- › **PART 3:** Group World-Building Brainstorm
- › **PART 4:** Individual World-Building Brainstorm
- › **PART 5:** Reflect
- › **PART 6:** Preview Next Activity

### PART 1: Welcome and Recap

---



1. Review the session breakdown.
2. Ask students to recall the EDP. Discuss what the diagram represents and what the process shows us.
3. Ask them to think about the clothespin challenge they took part in. Challenge them to pick one stage of the EDP they remember engaging in. Take a few minutes for a Think-Pair-Share: Ask students to remember the last session, and then turn to a neighbor and share what they recall about this stage of the cycle. After a few minutes, open up the conversation, asking pairs to share with the class what they recall.
4. Debrief students' understanding of the phases of the EDP, and clarify any misunderstandings. Remind them that the EDP, like any creative process, doesn't have to include all the phases. In addition, the phases may not occur in the order students see them in the graphic.
5. Remind students that over the course of the Maker Club sessions, they will create a world—a display of people, places, and things that interest them—and they will learn to use different tools and materials to make that world come to life. Remind them that they will celebrate their creative accomplishments by inviting their community to see their world and learn how they made it.

6. Explain that today they will:
  - › First, inventory the living and non-living things within the classroom.
  - › Next, make an object from the classroom out of paper.
  - › Last, brainstorm possible worlds to make and then list the things they want to include in the world they create.

## PART 2: Build a Paper World

---



1. Show students a piece of paper. Tell them that the paper is considered a 2D object. Ask students to share their observations about what the paper looks like and any ideas about what a 2D object is. Elicit that a 2D object is a flat figure or a shape with two dimensions—length and width.
2. Fold the paper in half so it can stand in a tent shape. Tell students the shape can now be described as a 3D object. Ask students what changed. Elicit that the paper now has height—which is what makes a 2D object different from a 3D object.
3. Tell students they are going to play around with this idea as you work together to make a 3D model of the classroom out of paper.
4. Ask students to name the living things they see in the classroom. Record their responses in the Living column of the first prepared chart.
5. Ask students to identify the non-living things in the room. List those items in the Non-living column of the chart.



## ADJUST AND SCALE

Students might enjoy adding a third column to their chart for new, fantastical objects that could be added to an existing world. Some questions to prompt student thinking are:

- › What brand-new object might be useful in your world?
- › What character, person, or animal might enjoy this world?
- › What new place might a character in this world like going to?

6. Review the lists and decide who will make what object.



## MAKING MORE

Some students may enjoy adding walls with windows, bulletin boards, or other items to this world. Doing so increases the challenge level and also may help other students better be able to place the objects they make in their relative locations by providing more points of reference in the space.



7. Give students one sheet of paper and 15 minutes to create their item. Ask students to place their object in the outlined shape on the floor, relative to its classroom location, as they finish.



## STICKY SPOT

If students find it difficult to create a 3D object from a piece of paper, consider offering additional supports such as:

- › breaking down objects into their elemental shapes. For example, a chair can be broken down into a rectangle (the back), a square (the seat), and four cylinders (the legs). Once individual shapes are identified, make one at a time before combining them into a final object.
- › looking at different paper manipulation techniques as a way to guide student work or provide inspiration.



Photo credit: [Art is Basic](#)

### Reflect

- What object did you make?
- How did you know where to place it?
- What was it like working with paper?
- If you did this again, would you pick the same object to make out of paper, or would you select a different one? Why?



8. Debrief the activity by posing questions, such as:

- › What object did you make?
- › How did you know where to place it?
- › What was it like working with paper?
- › If you did this again, would you pick the same object to make out of paper, or would you select a different one? Why?

## PART 3: Group World-Building Brainstorm

---



1. Explain that a *world* is where living and non-living things exist together. Worlds can be real places (like New York City, Saturn, or a train yard) or pretend (like Super Mario Brothers' Mushroom Kingdom, Jurassic Park, or Wonderland).
2. Explain that the class will come up with a world idea and brainstorm all the things that can go in it before students select their own world and objects.
3. Solicit world ideas from the class, jotting down suggestions on chart paper or the board. Determine which world the class would like to use to practice brainstorming the items they'd find there.
4. Use the second prepared chart to record ideas for items that one would find in the selected world, sorting them into the living and non-living categories as you go.

## PART 4: Individual World-Building Brainstorm

---

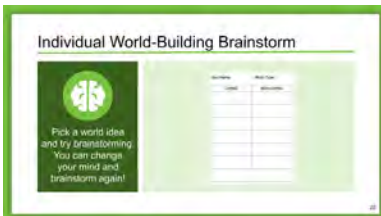

1. Give students time to decide on the world they'd like to create. Tell them that they can pick a world from the class brainstorm or come up with a different world they'd like to make.
2. Distribute a piece of paper, a Popsicle stick, and a pencil to each student. Ask them to write their name and the world they've chosen to create at the top of their paper.
3. Ask students to create a two-column chart either by folding the paper in half or drawing a line down the center. They can run the Popsicle stick down the fold to make it crisp. Ask students to label the columns Living and Non-living.





### ADJUST AND SCALE

If students struggle with the fine motor and eye-hand coordination demands needed for folding the paper in half, consider providing the [Activity 1: World Inventory Chart Template](#) for this part of the activity.

4. Challenge students to list or draw as many components of their world as they can imagine.



### STICKY SPOT

As the club progresses, students may change their mind about the world they want to make—which is fine. This exercise helps students think categorically, gives them a way to organize their ideas, and can easily be replicated with a new topic. Encourage them to pick a theme they are excited about. After all, the creative process is iterative!



### ADJUST AND SCALE

**Students might enjoy adding a third column to their chart for new, fantastical objects that could be added to an existing world. Some questions to prompt student thinking are:**

- › What character, person, or animal might enjoy this world?
- › What brand-new object might be useful to this character?
- › What new place might this character in the world like going to?

## PART 5: Reflect

---

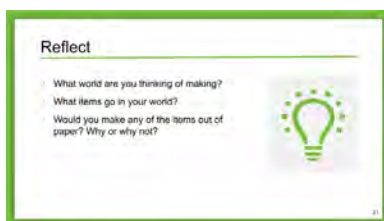

1. Engage the class in a conversation about their world ideas by posing questions, such as:
  - › What world are you thinking of making?

- › What items go in your world?
- › Would you make any of the items out of paper? Why or why not?

2. Collect students' brainstorming charts for Activity 2.

## PART 6: Preview Next Activity

---



In the next activity, students make a journal to capture their ideas and track their progress and reflections as they create their world. Today's brainstorming chart will be the center page of their journals. Distribute the [Activity 2 Primer](#), found in the Appendix.

# Activity 2: Make a Journal ★★☆☆☆



## Session Summary

---

Students construct journals to collect ideas, plans, and notes about the components of the world they want to make. Students will use these journals in subsequent sessions to reflect on their work and their maker experiences. The challenge level of this activity is rated three out of five stars.

## Learning Goal and Maker Skills

---

Students understand the purpose of documenting their ideas and progress. They design and fabricate their own journal and learn to sew a bookbinding, using a hammer and a nail, threading a needle, and sewing a basic stitch. They have the opportunity to learn to wrap a bookbinding using scissors and thread.

## Key Vocabulary

---

- › Binding
- › Hammer
- › Needle
- › Sewing
- › Spine

## Materials

For the Teacher	For Each Student	General Supplies
<p>Variety of materials with different bindings (e.g., newspapers, magazines, notebooks, textbooks, novels)</p> <p>Materials to make at least one wrapped and one bound journal</p> <p>1 sheet of cardstock for each journal type</p> <p>10 sheets of printer paper for each journal type</p>	<p>Activity 1 brainstorming chart</p> <p>Sheet of cardstock</p> <p>10 sheets of printer paper</p> <p>Popsicle stick</p> <p>4 binder clips</p> <p><b>For the Sewn Journal</b></p> <p>Embroidery needle</p> <p>Threader</p> <p>Foam block</p> <p>Embroidery thread</p> <p><b>For the Wrapped Journal</b></p> <p>48" piece of embroidery thread</p> <p>Scissors</p>	<p>Markers</p> <p>Pencils</p> <p>Pens</p> <p><b>For the Demonstration Table</b></p> <p>Large Popsicle sticks</p> <p>Binder clips</p> <p>Foam blocks</p> <p>Hammers</p> <p>3" nails</p> <p>Pencils</p> <p>Embroidery thread</p> <p>Scissors</p> <p>Threader</p> <p>Embroidery needle</p> <p><b>For the Supply Table</b></p> <p>Decorative materials (e.g., stickers, Washi tape)</p>

## Prep

- Watch the video [Lesson 1: Journal Making](#). If you are unfamiliar with the basic sewing skills of tying and/or tying off knots, watch *Tying a Knot* and/or *Tying Off a Knot* on the same webpage.
- Create at least one journal using each technique presented in this activity (sewn and wrapped bindings).

**Note:** For novice maker teachers, the wrapped binding can be a good option to present to students as it requires fewer materials and places less demands on fine motor skills.

- Collect some materials that have been bound in different ways, such as newspapers, magazines, notebooks, textbooks, and novels.
- Set up a demonstration table and a supply table. Have copies of the [Activity 2 Visual Guides](#) at the demonstration table.

## Activity Breakdown

---

- › **PART 1:** Welcome and Recap
- › **PART 2:** Taking a Closer Look
- › **PART 3:** Make a Journal
- › **PART 4:** Reflect
- › **PART 5:** Preview Next Activity

## PART 1: Welcome and Recap

---



1. Review the session breakdown.
2. Ask students to recall the world they began to imagine in Activity 1. Ask students to share the world they plan to make.
3. Explain that in today's session, students will:
  - › First, look at how pages stay inside books and other reading materials.
  - › Next, learn how to make their own journal to record their ideas and keep track of their progress.
  - › Last, decorate and personalize their journals.

## PART 2: Taking a Closer Look

---



1. Ask students what they know about journals. Ask: What are journals? Why might someone use one?

**Fun Fact:** The Italian inventor and artist Leonardo da Vinci is famous for his journals. It is estimated that he produced more than 20,000 pages of notes and sketches over his lifetime. He wrote his notes from right to left and backward—to read them you’d have to hold his notes up to a mirror (and understand Italian)! He took notes on everything that interested him—painting, engineering, perspective, geography, light and shade, and inventions. He included lots and lots of sketches too. The British Library has [digitized 570 pages of da Vinci’s journal pages](#).

2. Explain that everyone is going to make their own journal so they can jot down ideas, sketches, and notes about the components they want to make for their worlds.
3. Show students materials that have been bound in different ways. Ask them to share what they notice about how pages stay inside the covers.
4. Show students the sample journals you made. Give students time to examine the journals and share what they notice about how the journals are put together.

### PART 3: Make a Journal

**Note:** Pages 32–41 walk you through the steps of creating a journal with a sewn binding. Pages 41–45 explain how to create a journal with a wrapped binding.



1. Show the three-minute video [Lesson 1: Journal Making](#), which shows how to use the sewn binding technique. Review the three main steps: folding paper, making holes, and sewing the binding.
2. Return students’ brainstorming charts from Activity 1 so they can include them in the papers they will fold and bind into their journals.
3. Distribute 10 pieces of printer paper, a piece of cardstock, and a Popsicle stick to each student, or have students visit the supply table to pick up these materials on their own.



## TECHNIQUE 1: Make a Journal with a Sewn Binding

4. Demonstrate how to fold the pages, asking students to follow the steps as you do each one:



### ADJUST AND SCALE

Students who prefer to do this work on their own can use the [Activity 2 Visual Guide: Sewn Journal, Part 1 – Folding Pages](#) to guide them.



**FIRST**, fold a piece of cardstock in half along the long side.



**SECOND**, use the edge of a Popsicle stick to push along the fold and make it crisp.



**THIRD**, fold 10 pieces of printer paper in half at once.



**FOURTH**, use the edge of a Popsicle stick to push along the fold and make it crisp.



**FIFTH**, place the folded printer pages inside the folded cardstock.

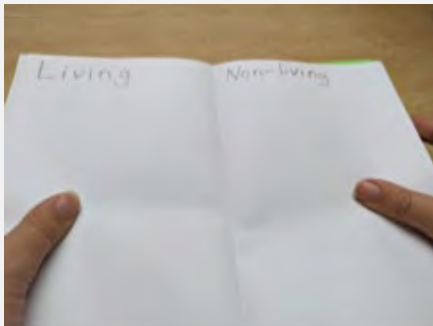

**LAST**, open the pages and insert your brainstorming chart in the center.



5. Have a group of students come to the demonstration table, where you will guide them on marking and hammering holes into the spines of their journals. Have the remaining students begin decorating their journal covers.
6. Use the instructions below to demonstrate how to make the holes down the center of the journal using the sample folded pages you just completed.





## ADJUST AND SCALE

Students who prefer to do this work on their own can use the [Activity 2 Visual Guide: Sewn Journal, Part 2 – Making Holes](#) to guide them.



**BEFORE YOU GET STARTED**, gather your supplies:

- › The stack of folded journal pages
- › 4 binder clips
- › Pencil
- › Foam block
- › Nail
- › Hammer



**FIRST**, attach a binder clip to each corner of the stacked journal pages.



## STICKY SPOT

Some learners may not have the dexterity or strength to open binder clips. Consider offering clothespins or jumbo paper clips as an alternative clamp.

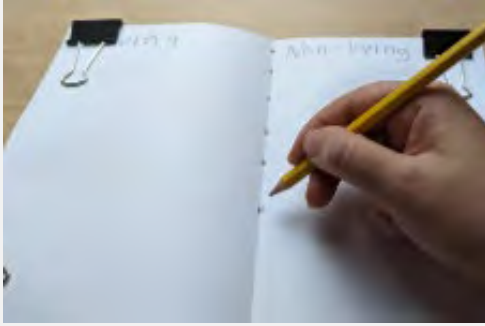

**SECOND**, use a pencil to mark holes down the center crease, about an inch apart.



### ADJUST AND SCALE

Depending on the ages and skill of your students, you can:

- Pre-mark each hole on the page
- Pre-mark every other hole and have students mark the rest of them
- Ask students to just make two holes



**THIRD**, place the journal pages onto the foam block.



**FOURTH**, place the nail on the first mark. Hold it in place by pinching it near the bottom.



**FIFTH**, use the hammer to gently tap the head of the nail. The nail will go through the pages and just into the top foam.



### ADJUST AND SCALE

Depending on the ages and skill of your students, you can consider making holes with a hole punch and using several strands of yarn for binding material.

**Note:** At this point, invite some volunteers to make holes. This will give them a feel for stabilizing the nail and the force needed to puncture the papers and foam.



**SIXTH**, remove the nail by pulling it out with one hand while pushing down on the papers with the other.  
**LAST**, repeat steps 6 and 7 until you have made a hole at each pencil mark.

7. Have students work in small groups to prepare for and then hammer holes down the spine of their journal.
8. As students finish making holes, invite them to decorate their journal covers. Bring new groups of students to the demonstration table until all have seen a demonstration and have completed making their holes.



## STICKY SPOT

If you divide the class in half during this skill-building step, with one group decorating covers while others are learning to hammer the holes, let the decorating group know that the holes will go down the center folds. This way, they can decide to include or avoid the spine as they decorate.



9. Demonstrate how to thread a needle by following the steps below. Alternatively, you can show the video [How to use a needle threader](#), which demonstrates how to thread a needle with this tool and how to tie the ends of the thread together.



## ADJUST AND SCALE

Students who prefer to do this work on their own can use the [Activity 2 Visual Guide: Sewn Journal, Part 3 – Threading the Needle](#) to guide them.



**BEFORE YOU GET STARTED**, gather your supplies:

- › The stack of journal pages with holes down the spine
- › Embroidery thread
- › Threader
- › Embroidery needle
- › Scissors



**FIRST**, cut off approximately 25" of embroidery thread.

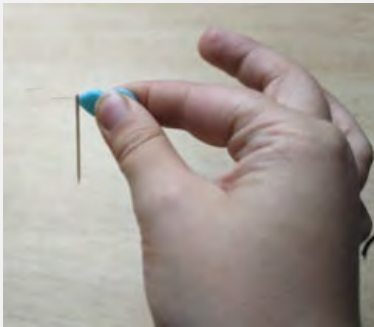

**SECOND**, push the threader all the way through the eye of the needle.



**THIRD**, loop the thread through the threader.



**FOURTH**, pull the needle off of the threader and onto the thread.



**FIFTH**, line up the two ends of the thread.



**SIXTH**, gently wrap the thread around your index finger and make an X, holding the tail with your thumb and middle finger.



**LAST**, place the needle underneath and through the X while continuing to hold the tail with your thumb and middle finger. Pull the threaded needle slowly to make a knot.



### STICKY SPOT

Depending on your students' ages and abilities, consider pre-threading needles and knotting thread ends together before the session and having extra threaded needles ready to go. Store pre-threaded needles in a block of foam, or tape them to the edge of a desk.



10. Demonstrate how to sew the binding using the steps below. Use a document camera if you have one so students can watch the process on a large screen or board. Alternatively, you can show [Lesson 1: Journal Making](#), starting at 2:25.



**FIRST**, start from the back of the journal and put the needle in the first hole.

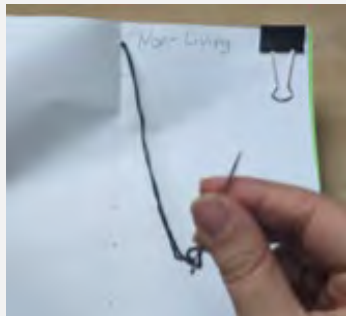

**SECOND**, flip over the journal and pull the needle and thread all the way through.

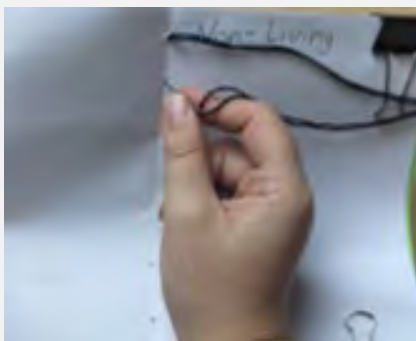

**THIRD**, place the needle in the next hole.

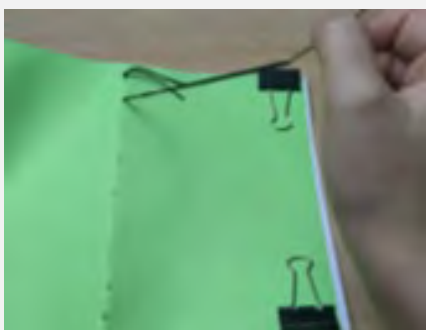

**FOURTH**, flip over the journal and pull the needle and thread all the way through. Repeat this pattern—inserting the needle in the next hole, flipping over the journal, and pulling the needle and thread through the hole—all the way to the last hole.



**LAST**, when you get to the end, loop the thread through itself a couple of times to make knots, and cut off the excess with scissors. Remove the binder clips.



**If you'd like to make your journal binding even stronger, try this optional last step.**

When you get to the last hole and pull the needle and thread through, bring the needle and thread over the top of the journal, and push it through the same hole from the opposite side. This will create a stitch that loops over the top.

Start sewing in the opposite direction, inserting the needle in the next hole, flipping over the journal, and pulling the needle and thread through until you get to the hole where you began.

Loop the thread through itself a couple of times to make knots, and snip off the excess with scissors.

Remove the binder clips.

11. Divide the class into smaller groups.
12. Distribute needles, thread and threaders, and scissors.
13. Give students time to bind their journals.





## STICKY SPOT

Sewing with ease takes time to develop, so definitely give the class a heads-up that this process may feel difficult or frustrating. Allow time for deep breaths, breaks, and restarts. It's common for new sewers to unintentionally knot their thread as they stitch or to go up through a hole when they meant to come down through it. For those makers with a low tolerance for snafus, consider working near them, modeling each move, then having the student repeat it. Also, have a few spare needles threaded and ready to go, as sometimes the only way out of a knotty situation is to cut the threads, remove the strands, and start again.

14. Suggest that students who complete their bindings and decorations continue adding to their brainstorming chart by listing or drawing additional people, places, and things they'd like to include in their world.



## MAKING MORE

Challenge students to figure out a way to make a pocket or a button closure and/or to find a way to store a pen or pencil in their journal. In addition to being creative problem-solving opportunities, making these features provides additional opportunity for eye-hand coordination and fine motor work.

## TECHNIQUE 2: Make a Journal with a Wrapped Binding



1. Return students' brainstorming charts from Activity 1 so they can include them in the papers they will fold and bind into their journals.
2. Distribute 10 pieces of printer paper, a piece of cardstock, and a Popsicle stick to each student, or have students visit the supply table to pick up these materials on their own.
3. Demonstrate how to fold the pages, asking students to follow the steps as you do each one:



## ADJUST AND SCALE

Students who prefer to do this work on their own can use the [Activity 2 Visual Guide: Wrapped Journal](#) to guide them.



**FIRST**, fold a piece of cardstock in half along the long side.



**SECOND**, use the edge of a Popsicle stick to push along the fold and make it crisp.



**THIRD**, fold 10 pieces of printer paper in half at once.



**FOURTH**, use the edge of a Popsicle stick to push along the fold and make it crisp.



**FIFTH**, put the folded printer paper and the brainstorming chart inside the folded cardstock.



**SIXTH**, open all pages at the middle page and attach binder clips to each corner.



**SEVENTH**, cut a triangle-shaped notch around the top and bottom creases of the journal, making sure to cut through all the pages.

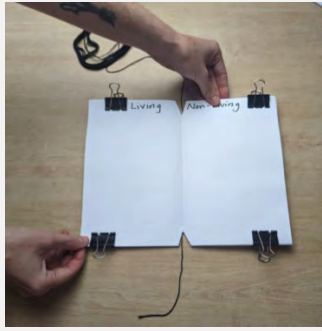

**EIGHTH**, cut a 48" long piece of embroidery thread. Lay the first 12" down on your work surface and place the journal on top of it, centering the thread in the notches.



**NINTH**, bring the cut end of the thread toward the top notch and make a knot.

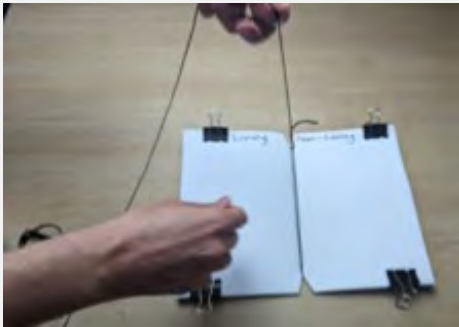

**TENTH**, wrap the embroidery thread around the journal, placing the thread in the notches at the top and bottom. Wrap the thread around the journal at least four times.

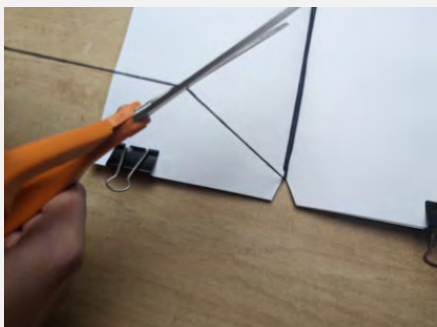

**ELEVENTH**, cut the embroidery thread, leaving a few extra inches at the end.



**TWELFTH**, tie a few knots by looping the embroidery thread underneath the wrapped binding.



**LAST**, remove your binder clips and close the journal.



### MAKING MORE

Students may be curious to try both journal binding methods. Encourage them to experiment with a second binding method on their own or in groups. Additional journals can be kept for themselves, brought home for others, or kept in the makerspace for others to use.

## PART 4: Reflect

---



Either in their journals or through a class discussion, have students respond to these prompts:

- › What did you enjoy most about today's activity?
- › What was most challenging? How did you deal with it?
- › What did you figure out today?
- › How could you improve your journal? What would you do differently?

## PART 5: Preview Next Activity

---



In the next activity, students experiment with clay, learn some techniques for working with clay, and select a character from their world-building brainstorm to make out of clay. Distribute the priming document titled [Activity 3 Primer](#), found in the Appendix.

# Activity 3: Work with Clay ★★☆☆☆



## Session Summary

Students choose a character from their world-building brainstorm and use clay and clay-sculpting tools to make a 3D version of that character. The challenge-level of this activity is rated two out of five stars.

## Learning Goal and Maker Skills

Students explore clay as a building material and begin to determine what objects, shapes, and textures are suitable to be made out of clay. Students learn several clay-shaping techniques, including rolling, coiling, and pinching, and how to add texture with clay-sculpting tools.

## Key Vocabulary

- › Coiling
- › Pinching
- › Sculpting

## Materials

For the Teacher	For Each Student	General Supplies
Butcher paper Air-dry clay	Air-dry clay Clay-sculpting tool Journal	Hand wipes Clay-sculpting tools Air-dry clay in assorted colors Markers Pencils Pens

## Prep

---

- › Cover the desks in butcher paper to protect them from stains and scrapes.
- › Have hand wipes available.
- › Have copies of the [Activity 3 Visual Guides](#) available at each workspace.
- › Set up a supply table with additional clay-sculpting tools and different colors of clay.

## Activity Breakdown

---

- › **PART 1:** Welcome and Recap
- › **PART 2:** Clay Exploration
- › **PART 3:** Clay-Shaping Techniques
- › **PART 4:** Create a Character
- › **PART 5:** Reflect
- › **PART 6:** Preview Next Activity

## PART 1: Welcome and Recap

---

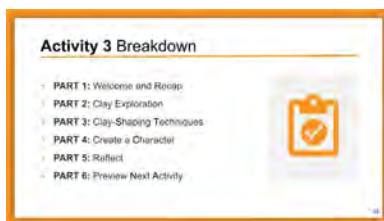

1. Review the session breakdown.
2. Ask students to recall what they did last time in Maker Club and what they made.
3. Explain that today students will:
  - › First, play with a piece of clay.
  - › Next, learn two different techniques for shaping clay: pinching and coiling.
  - › Last, create a character for their world using clay.



## PART 2: Clay Exploration

---

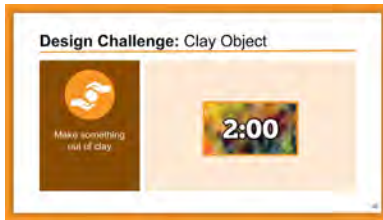

1. Explain that clay is one of the materials students will use to construct people or objects in their worlds.
2. Give each student a handful of clay, and give them 30 seconds to play with it. Observe the natural ways students manipulate the clay into shapes and objects. When time is up, encourage students to discuss their experiences by posing questions, such as:
  - › What does the material feel like?
  - › How did you manipulate it?
  - › What did you discover?
3. Give students two minutes to shape their clay into an everyday object. Then, ask students:
  - › What object did you make?
  - › How did you make it? Did you roll it in your hands or on the table? Did you flatten it? Poke it? Divide your clay into pieces?
  - › Did you try to make anything that didn't "work"? Why didn't it work? How did you fix it?
  - › What did you notice about working with clay?
  - › What objects in your world might be good to make out of clay? Why?

## PART 3: Clay-Shaping Techniques

---



4. Explain that students are going to learn two techniques for working with clay: *coiling* and *pinching*. Coiling and pinching are techniques for shaping objects out of clay that have been used for thousands of years.

5. Distribute three handfuls of clay to each student.
6. Instruct students to roll each chunk into a ball.
7. Start by introducing *pinching*. Ask students to select one ball and to follow the steps you demonstrate to make a pinch pot, as shown below.



### ADJUST AND SCALE

Students who prefer to do this work on their own can use the [Activity 3 Visual Guide: Clay, Part 1 – Pinching](#) to guide them.



**BEFORE YOU GET STARTED**, gather your supplies:

- › Clay
- › A clay knife

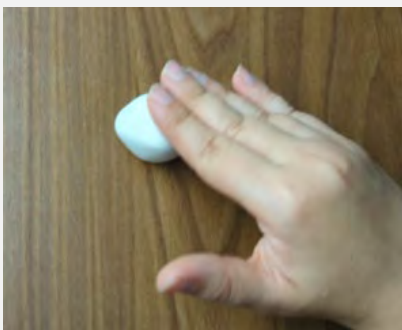

**FIRST**, place your palm on a chunk of clay, press down, and move your hand in a circular motion to roll the clay into a ball.



**SECOND**, press your thumb into the center of the clay ball, about halfway through.



**THIRD**, use your fingers to pinch around the edges of the clay. You want it to begin looking like a cup.



**FOURTH:** Place both thumbs in the cup and pinch the edges between your thumbs and other fingers to continue thinning out the sides of the cup.



**LAST**, smooth the edges with your thumb. What can you make using this shape?

8. Ask students to share some ideas about what objects they might make with this technique.
9. Instruct students to roll their pinch pots back into a ball.



10. Ask students to observe as you demonstrate *coiling*, as shown below. Alternatively, distribute clay knives to students, ask them to select two balls of clay, and have them follow each step as you demonstrate the technique.



### ADJUST AND SCALE

Students who prefer to do this work on their own can use the [Activity 3 Visual Guide: Clay, Part 2 – Coiling](#) to guide them.



**FIRST**, select a ball of clay and place your palm on top of it.

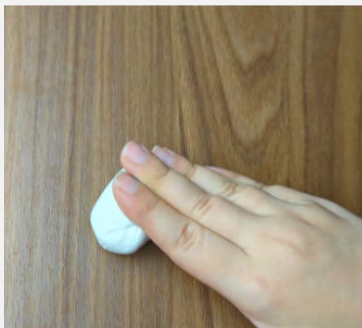

**SECOND**, lightly press down and move your hand back and forth, rolling the ball underneath your hand so it starts to get longer.



**THIRD**, use the tips of all your fingers to keep rolling the clay, moving your hands away from each other just slightly with each roll. Try to keep the cylinder from breaking. Your goal is to roll it the width of a finger.



**FOURTH**, smooth any cracks with your fingers.



**FIFTH**, make another roll. Your two rolls should be the same size.

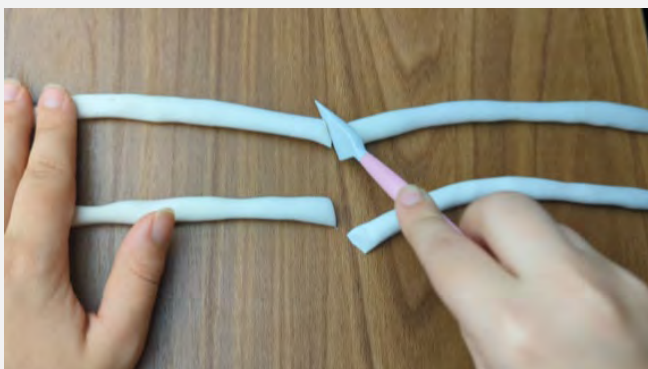

**SIXTH**, cut both rolls in half.



**SEVENTH**, roll one of the halves into a spiral.



**EIGHTH**, smooth over the grooves of your spiral with your finger. This is going to be the base of a cup.



**NINTH**, select one of your rolls and wrap it around the edge of your base. If it is too long, you can use your knife to cut it. This is your first coil.



**TENTH**, select another roll and coil it on top of the first. You want the ends to meet on the opposite side of where the ends of the first coil meet to increase stability.





**ELEVENTH**, keep building up your cup and adding coils! You may roll more clay as needed.



**LAST**, choose if you want to leave your cup coiled. If not, use your finger to smooth out the joints between the coils.

11. Ask students to share some ideas about what else they might make with coiled clay.
12. Distribute clay-sculpting tools, at least one for each student. Demonstrate how to use the tools to cut the clay, create dents and patterns, add texture, etc.

## PART 4: Create a Character

---



1. Distribute journals and have students review their brainstorming charts from Activity 1.
2. Ask students to think about who lives in their chosen world. Which characters or people are most suitable for making out of clay? They should think about each character's shapes and textures.
3. Ask students to choose one character or person from their brainstorm to make out of clay. Remind them to keep in mind what they just discovered about the properties of clay, ways to shape it, and ways to add detail.

4. Ask students to sketch their character on the first blank page of their journals. Prompt them to consider details about what their character looks like. For example:
  - › Is the character tall or short? Muscular? Skinny?
  - › If they have hair, what is it like?
  - › How old is your character?
  - › How does your character dress?
  - › What is the texture of their clothes or body parts?
  - › What is your character doing? How do they move their body?
  - › Is your character holding anything?
5. After 10 minutes or so, ask students to write down a plan for making their character, taking into account such questions as:
  - › What will they do first, second, and third?
  - › What color clay will they use?
  - › What clay-shaping techniques will they incorporate?



### ADJUST AND SCALE

Depending on the needs and abilities of your students, some might find sketching and planning frustrating or limiting. Consider allowing those students to begin working with the material right away. Using their hands to manipulate the material can help them begin to imagine characters or objects for the world.

6. Give students some time to bring their character sketches to life in clay. Remind them to incorporate physical details and textures, which they can do in a variety of ways:
  - › **Applique:** Adding clay to an existing form (such as adding cylinders to a head for hair)
  - › **Cutting:** Removing clay to create detail (such as cutting out circles from a slab for eyes)
  - › **Embossing:** Pushing stamps, patterned rollers, or other objects (e.g., rubber stamps, forks, pencils, paper clips) into the clay to create textures
7. Point out that there are additional clay-sculpting tools and different colors of clay on the supply table.



## PART 5: Reflect

---



Either in their journals or through a class discussion, have students respond to these prompts:

- › What was it like working with clay?
- › What did you enjoy most about today's activity?
- › What was most challenging? How did you deal with it?
- › What did you figure out today?

## PART 6: Preview Next Activity

---

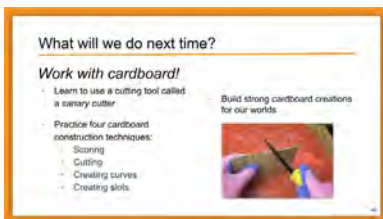

In the next activity, students explore various cardboard-manipulation techniques. Distribute the priming document titled [Activity 4 Primer](#), found in the Appendix.

# Activity 4: Work with Cardboard ★★☆☆☆

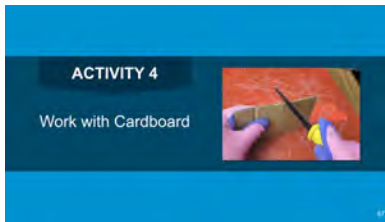

## Session Summary

Students use a cardboard-cutting tool called a *canary cutter* to practice four different cardboard construction techniques that will help them build stable, strong objects for their worlds. The challenge-level of this activity is rated three out of five stars.

## Learning Goal and Maker Skills

Students increase their materials fluency as they experiment with different cardboard-cutting techniques to score, cut, create curves, and attach pieces of cardboard.

## Key Vocabulary

- › Corrugated
- › Flute
- › Liner
- › Scoring

## Materials

For the Teacher	For Each Student	General Supplies
Cutting mats or larger sheets of cardboard for each work area Tape Cardboard Cardboard cutter or scissors	5 4" x 11" cardboard strips Cardboard cutter Ruler Pencil Tape Journal Gloves	Markers Pens Pencils Scissors Glue

## Prep

---

- › Place cutting mats or tape down large sheets of cardboard at each student's work area.
- › Pre-cut five 4" x 11" cardboard strips per student.
- › At each workstation, have ready: one pair of safety gloves for each student (to be worn when using the cardboard cutters), a ruler, a pencil, and tape.

## Activity Breakdown

---

- › **PART 1:** Welcome and Recap
- › **PART 2:** Cardboard Introduction and Exploration
- › **PART 3:** Cardboard Construction Techniques
- › **PART 4:** Sketch Your Ideas
- › **PART 5:** Reflect
- › **PART 6:** Preview Next Activity

## PART 1: Welcome and Recap

---



1. Review the session breakdown.
2. Ask students to recall what they did last time in Maker Club.
3. Explain to students that today, they will:
  - › First, learn how to use a cardboard cutting tool called a *canary cutter*.
  - › Next, practice four different cardboard construction techniques:
    - Scoring
    - Cutting

- Creating curves
- Creating slots
- › Last, build strong cardboard creations for their worlds.

## PART 2: Cardboard Introduction and Exploration

---

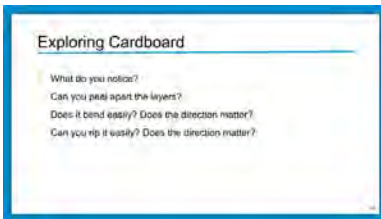

1. Pass out a strip of cardboard to each student, and encourage them to look closely at the material. Ask:
  - › Does it bend? Can you peel apart the layers? Can you rip it?
2. Ask students what they noticed.
  - › What was easy or hard to do?
  - › What do you think this material is made out of?
3. Explain that this type of cardboard is called *corrugated cardboard* and is made out of wood, just like paper. Corrugated cardboard is essentially a paper sandwich: There is a top layer and a bottom layer with a squiggle in the middle. The top and bottom layers are called *liners*, and the squiggle is called a *flute*. The flute is what gives cardboard its strength.
4. Explain that when we work with cardboard, it's important to pay attention to the different layers so we can manipulate the cardboard in different ways.

## PART 3: Cardboard Construction Techniques

---

1. Tell students that the first technique you will demonstrate is called *scoring*—a technique that lets us create crisp folds and edges.
2. Explain that cardboard cutters are sharp, and it is important to use them safely.
3. Ask students to observe as you demonstrate this technique, as shown below.



## ADJUST AND SCALE

Students who prefer to do this work on their own can use the [Activity 4 Visual Guide: Cardboard, Part 1 – Scoring](#) to guide them.



**BEFORE YOU GET STARTED**, gather your supplies:

- › Protective gloves
- › A piece of cardboard
- › A cardboard cutter
- › A pencil
- › A ruler
- › Tape



**FIRST**, put on your gloves and then use the pencil and ruler to draw a straight line in the center of the cardboard.



**SECOND**, place the blade of the cardboard cutter at the top of the line and press down gently so it pierces just the top layer of cardboard.



**THIRD**, while using your free hand to hold the cardboard in place, slide the cardboard cutter down the entire pencil line, continuing to push down gently to pierce the top layer.

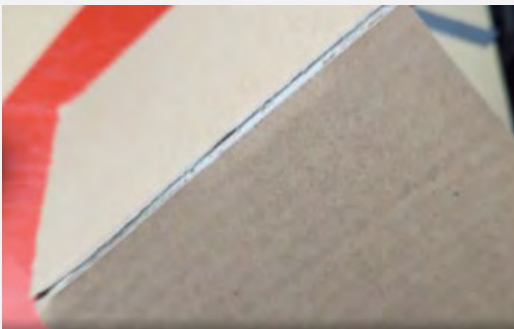

**FOURTH**, fold and snap the cardboard along the scored line.



**FIFTH**, use the ruler to draw a second line halfway between the left edge of the cardboard and your first scored line.



**SIXTH**, use the ruler to draw a third line halfway between the right edge of the cardboard and your first scored line.



**SEVENTH**, score the first new line.



**EIGHTH**, snap the first new line.



**NINTH**, score the second new line.



**TENTH**, snap the second new line.





**ELEVENTH**, connect the two ends of the cardboard.



**TWELFTH**, peel off a piece of tape about the same length as the cardboard.



**LAST**, place the tape along the connecting point of the two sides of the cardboard.

4. Assign student partners and instruct pairs to find a workstation and put on the safety gloves they find there.
5. Pass out one strip of cardboard to each student.
6. Ask students to decide which partner will score first.
7. Talk students through Steps 1–3 on slide 51, moving through the classroom to support students as needed.
8. Ask students to switch roles.





## ADJUST AND SCALE

- If cardboard cutters aren't ideal (or available) for your students, they can use scissors to score and cut the cardboard. To score cardboard, open the scissors and use one blade to pierce through the top layer.
- If you have concerns about students using the suggested cardboard cutters, which have two cutting edges, consider folding a piece of masking tape over the top exposed edge.

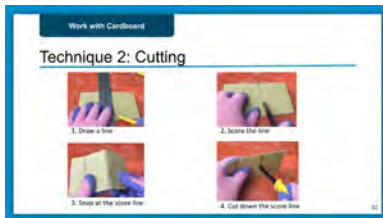

9. Explain that the next technique you will demonstrate is called *cutting*. To cut cardboard, you score it, stand it on its edge, and then saw along the score line.
10. Ask students to observe as you demonstrate *cutting*, as shown below.



## ADJUST AND SCALE

Students who prefer to do this work on their own can use the [Activity 4 Visual Guide: Cardboard, Part 2 – Cutting](#) to guide them.



**BEFORE YOU GET STARTED**, gather your supplies:

- › Protective gloves
- › A piece of cardboard
- › A cardboard cutter
- › A ruler
- › A pencil



**FIRST**, put on your gloves and then use the pencil and ruler to draw a straight line halfway across the cardboard.

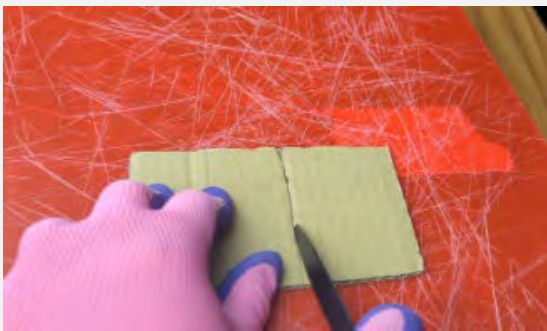

**SECOND**, place the blade at the top of the line and press down so it pierces the top layer of cardboard.



**THIRD**, snap the cardboard along the scored line.



**FOURTH**, stand the cardboard upright, place the cardboard cutter on the scored line, and begin to apply downward pressure.



**FIFTH**, saw the cardboard in two by pressing down on the cutter as you move it forward and back. Keep sawing until you reach the bottom.

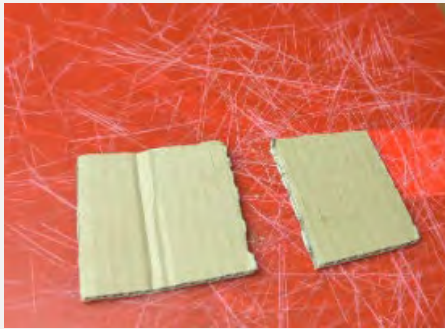

**LAST**, remove the cut piece of cardboard from the sheet. Congratulations! You cut a piece of cardboard.

11. Pass out another strip of cardboard to each student.
12. Ask students to decide which partner will cut first and who will help as needed.
13. Talk students through Steps 1–4 on slide 52, moving through the classroom to support students as needed.
14. Ask students to switch roles.

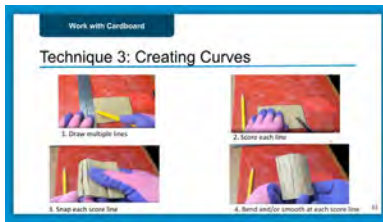

15. Tell students that the next technique you will demonstrate is *creating curves*. To do this, students score the cardboard in small, even intervals, bending the cardboard at each score mark until it starts to curve.
16. Ask students to watch as you demonstrate this technique, as shown below.



### ADJUST AND SCALE

Students who prefer to do this work on their own can use the [Activity 4 Visual Guide: Cardboard, Part 3 – Creating Curves](#) to guide them.

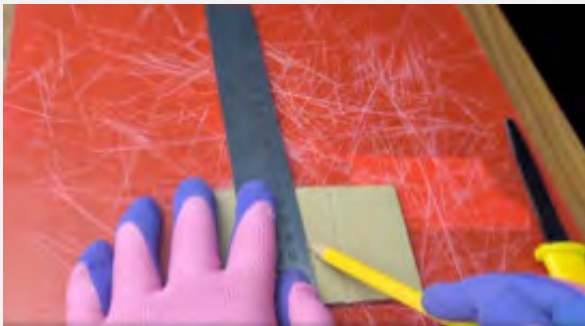

**FIRST**, use the pencil and ruler to draw a straight line halfway across the cardboard.

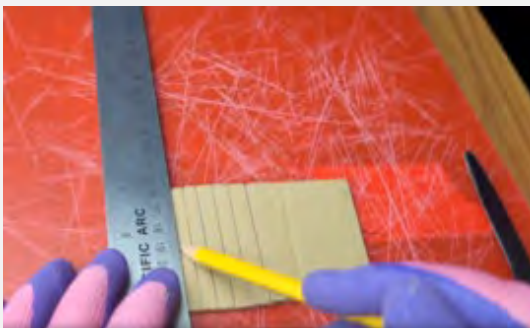

**SECOND**, use the pencil and ruler to draw multiple lines close to each other on both sides of the first line.



**THIRD**, score along all the drawn lines.

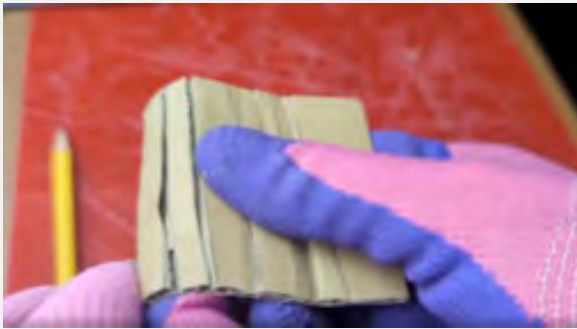

**FOURTH**, bend the cardboard along the scored lines. This will start to create a curve.

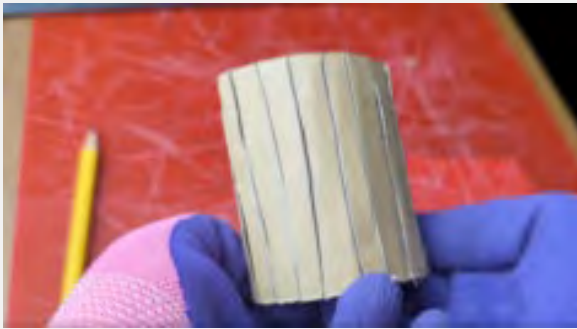

**LAST**, make sure all the scored lines are bent.

17. Pass out another strip of cardboard to each student.
18. Ask students to decide which partner will create curves first and who will help as needed.
19. Talk students through Steps 1–4 on slide 53, moving through the classroom to support students as needed.
20. Ask students to switch roles.



21. Tell students that the last technique you will demonstrate is *creating slots*.
22. Ask students to observe as you demonstrate this technique, as shown below.



### ADJUST AND SCALE

Students who prefer to do this work on their own can use the [Activity 4 Visual Guide: Cardboard, Part 4 – Creating Slots](#) to guide them.



**FIRST**, use your pencil to draw a narrow triangle centered at the top edge of the cardboard.



**SECOND**, stand the cardboard up and saw along one pencil line.





**THIRD**, saw back and forth along the other pencil line.



**FOURTH**, remove the triangle.



**FIFTH**, create slots on your other pieces of cardboard, and connect the pieces by sliding slots into other slots.



**LAST**, experiment with connecting multiple pieces of cardboard.

23. Pass out another strip of cardboard to each student.
24. Ask students to decide which partner will create slots first and who will help as needed.
25. Talk students through Steps 1–4 on slide 54, moving through the classroom to support students as needed.
26. Ask students to switch roles.

## PART 4: Sketch Your Ideas

---



1. Distribute journals, and ask students to review their brainstorming charts from Activity 1.
2. Ask students to pick one item from their list to make out of cardboard, keeping in mind what they learned about cardboard and the different ways to manipulate it.



### STICKY SPOT

Students may quickly discover that the smaller the cardboard object, the harder it is to manipulate the cutting tool and cut accurately. Depending on your students, you can opt to inform them of this potential challenge as they begin sketching or leave it to discovery and in-the-moment redesign and/or problem solving.

3. Prompt students to think about how they'd use cardboard to build this item. Ask:
  - › What is this item used for?
  - › What is the size of this item in comparison to your characters?
  - › Do characters interact with this item? Is it something they should be able to fit inside? Go on top of?
  - › Is it something a character brings with them?
  - › Will the structure fit inside your storage box?
  - › What techniques will you use to make this structure?



4. Ask students to sketch their ideas and to list the cutting techniques they will use in their journals.



### ADJUST AND SCALE

Depending on the needs and abilities of your students, some might find sketching and planning frustrating or limiting. Allowing those students to begin working with and using their hands to manipulate the material can help them begin to imagine characters or objects for their world.



### MAKING MORE

There is so much you can do with cardboard. Inspire students to make arcade games out of cardboard by watching the video [Caine's Arcade](#). This nine-year-old boy's fascination with, love of, and talent for cardboard construction [inspired a movement!](#)

## PART 5: Reflect

---

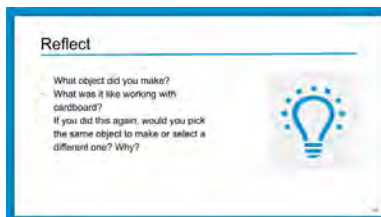

Either in their journals or through a class discussion, have students respond to these prompts:

- › What object did you make?
- › What was it like working with cardboard?
- › If you did this again, would you pick the same object to make or select a different one? Why?

## PART 6: Preview Next Activity

---

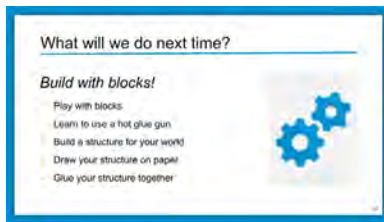

In the next activity, students explore how to make block sculptures using hot glue guns. Distribute the priming document titled [Activity 5 Primer](#), found in the Appendix.

# Activity 5: Build with Blocks ★★☆☆☆



## Session Summary

---

Students create 3D block sculptures for their world. They then diagram their structures and use the diagram to recreate their creation at a hot glue gun station. The challenge-level of this activity is rated three out of five stars.

## Learning Goal and Maker Skills

---

Students gain confidence and experience with using a new tool: a hot glue gun. When they transfer a 3D object to a 2D drawing, students come to understand that creating *diagrams*, or visual representations, of planned objects can be a helpful tool in the Engineering Design Process.

## Key Vocabulary

---

- › 3D model
- › Block
- › Diagram
- › Sculpture

## Materials

For the Teacher	For Each Student	General Supplies
Butcher paper Foam blocks Hot glue gun Hot glue sticks and/or glue dots Optional: Chart paper and markers	10–12 foam blocks Journal	Markers Pens Pencils Glue dots <b>Hot Glue Station</b> Butcher Paper Hot glue gun Glue sticks

## Prep

- › Create a hot glue station near an outlet. Cover the worksurface in butcher paper to prevent hot glue from sticking to it.

**Note:** Depending on the number of outlets and glue guns available, you may have multiple hot glue stations. Ideally, staff will be available at each station to assist students with the glue guns.

- › Preheat the hot glue guns.
- › Place a nickel-sized flat circle of hot glue on the center of several foam blocks and let it dry. This will show students how much glue is needed to adhere objects to each other.



### ADJUST AND SCALE

Using glue dots instead of hot glue for this activity is a great alternative if you don't have staff to facilitate a hot glue station and/or if using hot glue with your students is not your preference. Glue dots are incredibly strong and will easily hold a foam block (or even wood block) structure intact. Using glue dots will also allow you to reuse your blocks throughout the club.

## Activity Breakdown

---

- › **PART 1:** Welcome and Recap
- › **PART 2:** Exploring Blocks
- › **PART 3:** Hot Glue Gun (or Glue Dots) Overview
- › **PART 4:** Block Sculptures
- › **PART 5:** Diagramming
- › **PART 6:** Reflect
- › **PART 7:** Preview Next Activity

## PART 1: Welcome and Recap

---



1. Review the session breakdown.
2. Ask students:
  - › What did we do last time in Maker Club?
  - › What tools or materials did we use?
  - › What did we make?



3. Share that in today's session, students will create a block sculpture for their world. They will:
  - › First, explore blocks and learn how to use a glue gun safely.

- › Next, build a block sculpture for their world and create a diagram for it.
- › Last, glue their sculpture together.

## PART 2: Exploring Blocks

---

1. Show a block to the class. Ask them to describe what a block is.
  - › A *block* is a 3D object, typically flat-surfaced, that can be stacked with other flat-surfaced 3D objects.

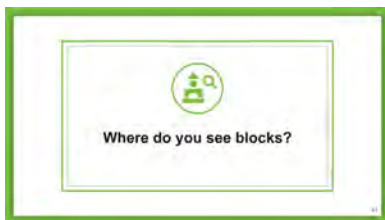

2. Ask students where they see “blocks” in their homes. Students may suggest toys, such as building blocks, Jenga, LEGOs, or Minecraft bricks, or they may mention brick or stone walls. Ask students:
  - › Why might someone want blocks to stay in place?
  - › In what ways can blocks be attached or held in place?
3. Ask students to explain the differences between 2D and 3D objects, and write their responses on the board.



4. Pass out 10–12 blocks per student and give them 15 minutes to play with their blocks. Encourage them to make different structures and shapes with their blocks, ultimately landing on a structure or sculpture they’d like to include in their world. Explain that students will use either a hot glue gun or glue dots to connect the blocks in their sculptures so they’ll stay connected.



## ADJUST AND SCALE

Depending on the age and ability of students, stacking and balancing blocks can prove to be a significant challenge and source of frustration. Tracing tangrams or pattern block arrangements can be used as an alternative. Shape stencils may also be suitable materials for students with fine motor challenges. Even pipe cleaners or magnetic blocks are options for exploring the idea of individual shapes working together to make larger structures.

## PART 3: Hot Glue Gun (or Glue Dots) Overview

### Hot Glue Gun

1. Explain that the job of a hot glue gun is to melt a stick of glue. Once melted glue is squeezed onto an object, it takes a few minutes to dry and cool. When the melted glue dries, it becomes very strong—stronger than craft glue—and is a great way to quickly attach things.
2. Point out that the metal tip and front of the hot glue gun are HOT, so the gun is ALWAYS and ONLY held by the handle.
3. Show students the examples you prepared, noting that you applied glue in the center of the block. If the glue is too close to the edges, it will ooze down the sides.



4. Demonstrate how to:
  - › Insert a new glue stick into the hot glue gun, pointing out the part of the gun that pushes the glue stick through the heating component of the tool.
  - › Hold a block from the sides to keep fingers away from hot glue.
  - › Gently pull the trigger to squeeze out the glue. Point out that the glue is hot enough when it comes out easily with a light pull. The glue gun is not hot enough if you pull the trigger and nothing comes out.
  - › Dispense a flat, nickel-sized amount of glue at the center of a block.

## Glue Dots: Some Tips

1. Bring the object to the glue dot, not the glue dot to the object. The glue dots are sticky and will adhere to fingers before sticking to the object!
2. If you have to remove glue dots from the roll or strip of paper they come on, consider using a clay-shaping tool from Activity 3 to take them from the paper and to place them on the object.

## PART 4: Block Sculptures

---

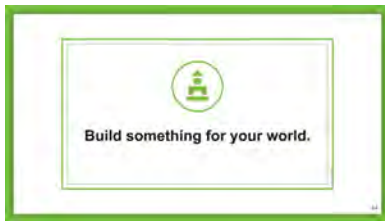

1. Distribute journals, and ask students to review their brainstorming chart from Activity 1, thinking about which items are best suited for making out of blocks.
2. Give students time to construct an object for their world with blocks.

## PART 5: Diagramming

---

1. Ask students to leave their sculptures in place and to gather at the demonstration table.
2. Ask students:
  - › What is a diagram?
    - A *diagram* is a simple drawing that shows what something looks like.
  - › Why can it be helpful to create diagrams? What step of the EDP do you think diagramming falls into?
  - › How might a diagram be useful when you bring your blocks to the hot glue station?

Point out that creating a diagram will help them recreate their structure at the hot glue station.



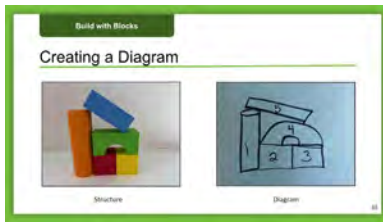

3. Model the process for creating a diagram with a simple block sculpture:
  - › First, make a five-block sculpture, asking students to notice the order in which you placed each one.
  - › Next, draw the sculpture block by block.
  - › Last, number the shapes in the order they were placed, as shown in the example on the slide.
4. Ask students to return to their work spots and work on diagramming their sculptures on the next blank page in their journals.
5. Have students bring their completed diagrams and blocks to a hot glue stations and begin to connect the blocks with hot glue, referring to their diagrams as they rebuild their sculptures.



### ADJUST AND SCALE

- › Depending on students' ages and abilities, consider talking about the names of the shapes of the blocks (cube, cylinder, etc.), and drawing and labeling them on the board.
- › For older students, consider suggesting that they add labels to their diagrams, such as the names of block shapes, or notes about where they will place the glue.

## PART 6: Reflect

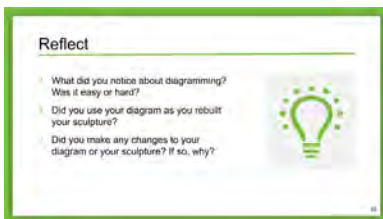

Either in their journals or through a class discussion, have students respond to these prompts:

- › What did you notice about diagramming? Was it easy or hard?
- › Did you use your diagram as you rebuilt your sculpture?
- › Did you make any changes to your diagram or your sculpture? If so, why?

## PART 7: Preview Next Activity

---

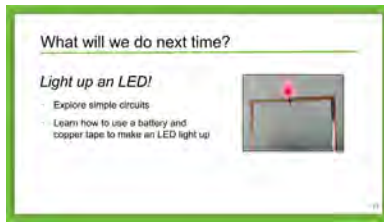

In the next activity, students explore simple circuits as they learn how to use a battery and copper tape to make an LED light up. Distribute the priming document titled [Activity 6 Primer](#), found in the Appendix.

# Activity 6: Light Up an LED ★★☆☆☆



## Session Summary

---

Students explore simple circuits as they learn how to use a battery and copper tape to make an LED light up. The challenge level of this activity is rated four out of five stars.

## Learning Goal and Maker Skills

---

Students learn the mechanics of a simple circuit, developing the understanding that a *circuit* is an uninterrupted path through which electricity continuously moves.

## Key Vocabulary

---

- › Circuit
- › Conductive
- › Conductors
- › Lead
- › LED
- › Negative
- › Polarity
- › Positive
- › Traces

## Materials

For the Teacher	For Each Student	General Supplies
Sample simple circuit Simple Circuit Template (see Prep for details) Several LEDs Several coin cell batteries Medium binder clip 15" strip of copper tape Cellophane tape	Journal Simple Circuit Template <b>In a sandwich bag:</b> <ul style="list-style-type: none"><li>› LED</li><li>› Coin cell battery</li><li>› 15" strip of copper tape</li><li>› Medium binder clip</li><li>› Cellophane tape</li></ul>	Colorful paper Markers Pens Pencils Scissors

## Prep

- › Make a sample simple circuit using [Activity 6 Circuit Template: Square](#), found in the Appendix. You will need copper tape, a coin cell battery, an LED and a binder clip to do this.



### ADJUST AND SCALE

Depending on students' ages and abilities, the square template can be quite a challenge to complete due to the long lengths of copper tape needed to get around the square and the need to ensure a continuous path of copper tape around the entire trace. As an alternative, consider providing students with the [Activity 6 Simple Circuit Template: Straight Lines](#). Students will learn the exact same concepts while manipulating shorter lengths of copper tape.

- › Make copies of the Simple Circuit Template of your choice for each student.
- › Make a sandwich bag of circuit supplies for each student (LED, 15" of copper tape, coin cell battery, cellophane tape, and binder clip).
- › Have copies of the [Activity 6 Visual Guide: Light-Up an LED: Square](#) and [Activity 6 Visual Guide: Light-Up an LED: Straight Lines](#) available.

## Activity Breakdown

---

- › **PART 1:** Welcome and Recap
- › **PART 2:** Inspiration
- › **PART 3:** How Does a Circuit Work?
- › **PART 4:** Try It!
- › **PART 5:** Reflect
- › **PART 6:** Preview Next Activity

## PART 1: Welcome and Recap

---

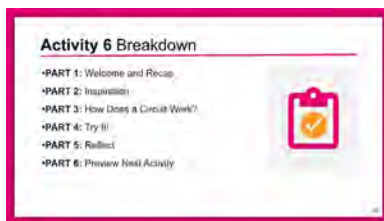

1. Review the session breakdown.
2. Ask students what they recall from the last session. Ask them to share what was easy or challenging about working with blocks and hot glue. Remind them that blocks are one material they can consider using when making objects for their worlds.



3. Share that in this activity students will learn how to make an LED illuminate using a battery and copper tape. They will:
  - › First, get inspired by watching a video about a piece of artwork that uses batteries, lights, and copper tape.
  - › Next, learn how a simple circuit works.
  - › Last, use the materials they are given to make an LED light up on their own.

## PART 2: Inspiration

---



**Show the video** of artist Jie Qi's installation *Dandelion Painting*. Ask students to think about how the intricate layout of copper tape and LEDs (and sensors and coding) make this artwork come to life.

## PART 3: How Does a Circuit Work?

---

1. Invite a few volunteers to the front of the class.
2. Hand each of them an LED and a battery and ask what they notice about each item. Ask the volunteers to figure out how to illuminate the LED. Once they do, ask what they discovered about making the LED light up.
3. Explain that they created a *circuit*—a path around which electricity can flow. Tell students:
  - › Any circuit must include a source of electricity, such as a battery.
  - › Materials that allow an electric current to pass through them easily are *conductive*. These materials, called *conductors*, can link the positive and negative ends of a battery, thus making a circuit.
  - › As long as the path is uninterrupted, the LED goes on and stays on!

## PART 4: Try It!

---

1. Show students your sample circuit. Close the circuit with a binder clip so the LED illuminates. Ask students to identify the LED and the conductors. Ask them why the binder clip is important (it provides constant pressure, assuring that the battery and copper tape remain in contact).

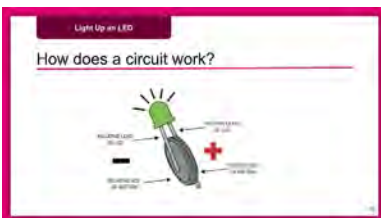

2. Show the circuit diagram found on slide 72.
3. Distribute journals, and ask students to turn to the next blank page and copy the diagram into their journals.

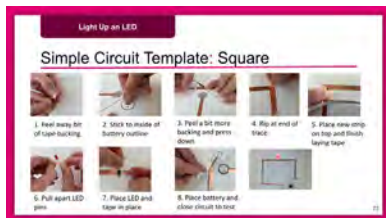

4. Ask students to observe as you demonstrate how to work with either the [Activity 6 Simple Circuit Template: Square](#) or the [Activity 6 Simple Circuit Template: Straight Lines](#) (both shown below).



### ADJUST AND SCALE

Students who prefer to do this work on their own can use the [Activity 6: Visual Guide](#) to guide them.

## Simple Circuit: Square

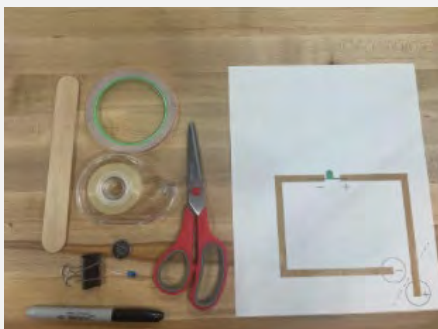

**BEFORE YOU GET STARTED**, gather your supplies:

- › 15" strip of copper tape
- › LED
- › Coin cell battery
- › Binder clip
- › Cellophane tape
- › Simple Circuit Template: Square
- › Popsicle stick



**FIRST**, pull the backing off a short strip of the copper tape.



### STICKY SPOT

Copper tape can tear or get stuck on itself. Guide the copper tape along the traces while removing only a small amount of backing at a time.

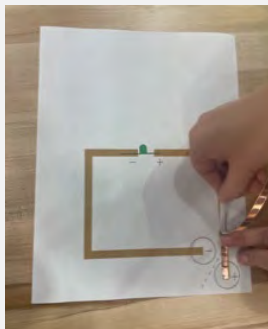

**SECOND**, place the edge of the tape at the start of the trace and slowly work your way up, using your finger or the edge of a Popsicle stick to push down the tape and make it smooth.



### STICKY SPOT

Smoothing down the tape as you go can be tough. Use the edge of a Popsicle stick to smooth out any wrinkles or bumps.

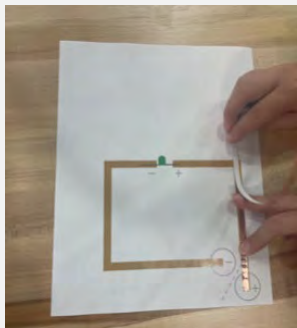

**THIRD**, remove the next small section of backing, then use your thumbnail to push down the tape and make it smooth.





**FOURTH**, when you get to the end of a trace, rip the tape and overlap the start of a new piece on top of the strip you just finished.

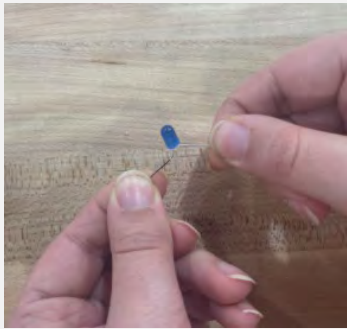

**FIFTH**, pull apart the leads of the LED.



### STICKY SPOT

Remembering the polarity of the LED leads and each side of the battery can be a source of frustration. It can be helpful to color the negative lead of the LED and the negative side of the battery with the same color to indicate matching polarities. A marker is good for this.

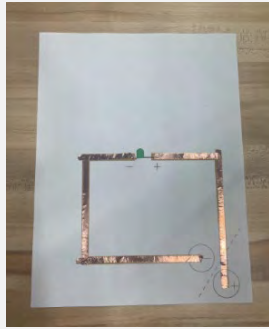

**SIXTH**, lay the LED on the copper tape and tape it down.

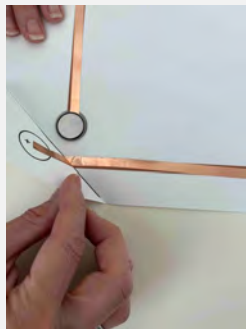

**SEVENTH**, place the battery on the designated area of the template and fold the corner over it.

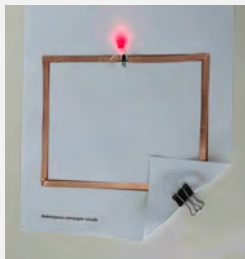

**LAST**, attach the binder clip to the folded corner.



### STICKY SPOT

LEDs don't always light the first time. Double-check that the polarities of the battery, LED, and tape match.

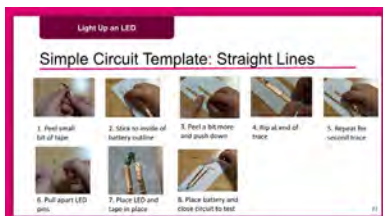

## Simple Circuit: Straight Lines

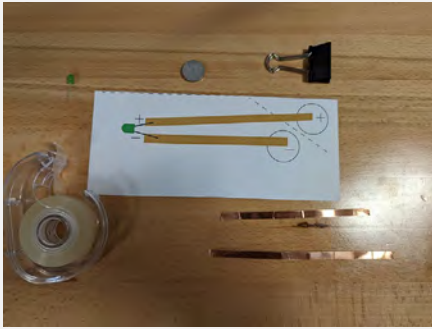

**BEFORE YOU GET STARTED**, gather your supplies:

- › Two strips of copper tape
- › LED
- › Coin cell battery
- › Binder clip
- › Cellophane tape
- › Simple Circuit Template: Straight Lines



**FIRST**, pull the backing off a short strip of the copper tape.



### STICKY SPOT

Copper tape can tear or get stuck on itself. Guide the copper tape along the traces while removing only a small amount of backing at a time.

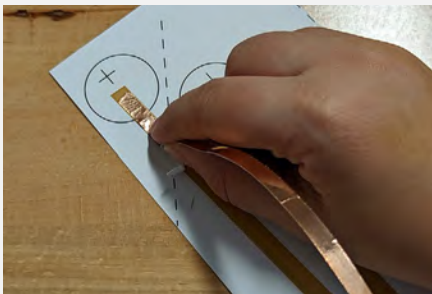

**SECOND**, place the edge of the tape at the start of the positive trace and slowly work your way up, using your finger to push down the tape and make it smooth.

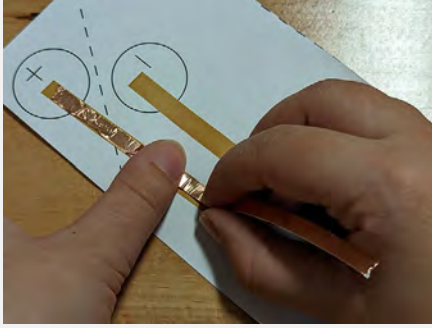

**THIRD**, remove the next small section of backing, then use your thumbnail to push down the tape and make it smooth.

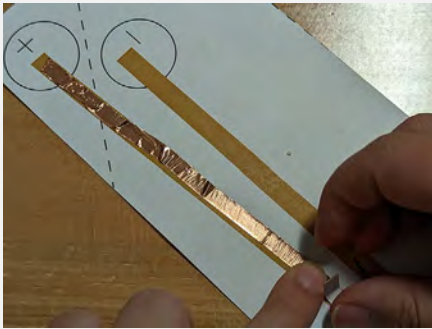

**FOURTH**, finish placing tape along the positive trace. Tear or cut the end of the tape if it is longer than the trace.



**FIFTH**, pull the backing off the other strip of the copper tape.

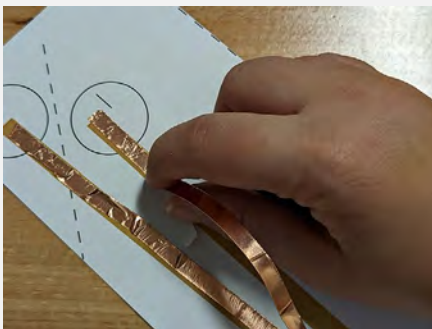

**SIXTH**, place the edge of the tape at the start of the negative trace and slowly work your way up, using your finger or the edge of a Popsicle stick to push down the tape and make it smooth.

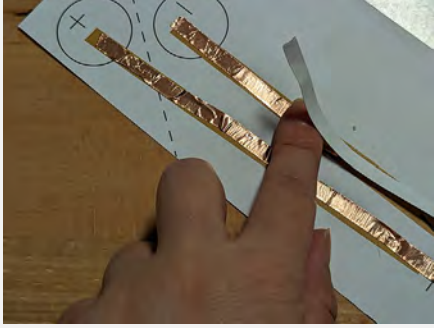

**SEVENTH**, remove the next small section of backing, then use your thumbnail to push down the tape and make it smooth.

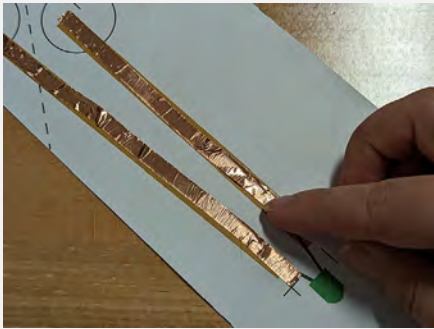

**EIGHTH**, finish placing tape along the negative trace. Tear or cut the end of the tape if it is longer than the trace.



**NINTH**, make sure your two pieces of copper tape stretch from inside the battery circles and cover the entire trace. The two pieces of tape should not be touching each other.

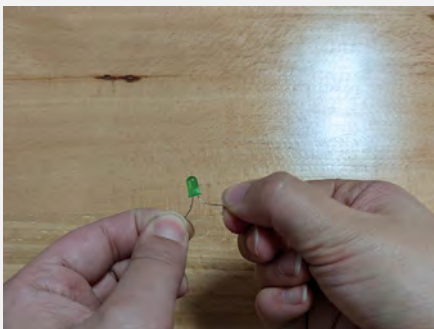

**TENTH**, pull apart the leads of the LED.

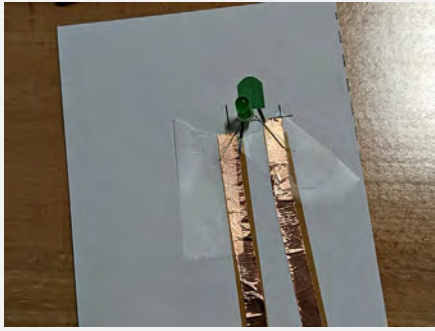

**ELEVENTH**, lay the LED on the copper tape and tape it down.

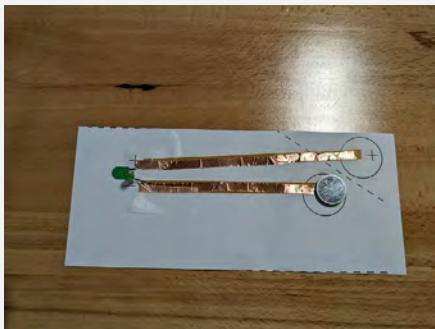

**TWELFTH**, place the battery on the designated area of the template. The positive side of the battery should be face up.



**THIRTEENTH**, fold the corner of the paper along the dashed line. When folded, the positive side of the battery will be touching the positive wire, completing the circuit.

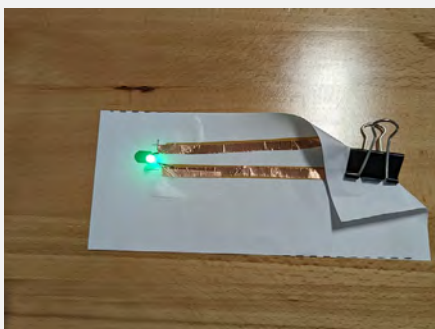

**LAST**, attach the binder clip to the folded corner.





## STICKY SPOT

LEDs don't always light the first time. Double-check that the polarities of the battery, LED, and tape match.

5. Distribute a Simple Circuit Template and a bag of supplies to each student.
6. Have students begin by placing the copper tape along the traces. Remind them to smooth it down by running their finger, or the edge of a Popsicle stick, along its length.
7. Have students follow the steps you demonstrated to complete their circuits.

## PART 5: Reflect

---



Either in their journals or through a class discussion, have students respond to these prompts:

- > What did you enjoy most?
- > What was most challenging? How did you deal with it?
- > What did you figure out today?
- > What would you do differently?

## PART 6: Preview Next Activity

---



In the next activity, students expand their exploration of simple circuits by creating a light-up sign for their worlds. Distribute the priming document titled [Activity 7 Primer](#), found in the Appendix.

# Activity 7: Make a Light-Up Sign ★★☆☆☆



## Session Summary

---

Students build on what they learned about circuits in Activity 6 to design a light-up sign to showcase the name of their world. The challenge-level of this activity is rated four out of five stars.

## Learning Goal and Maker Skills

---

Students employ and build on their knowledge of circuits to design, create, and test a light-up sign.

## Key Vocabulary

---

- › Circuit
- › Conductive
- › Lead
- › LED
- › Negative
- › Polarity
- › Positive



## Materials

---

For the Teacher	For Each Student	General Supplies
Half sheet of printer paper	Journal	Markers
Copper tape	Half sheet of printer paper	Pens
Colored LED	Copper tape	Pencils
Coin cell battery	LED	Crayons
Binder clip	Coin cell battery	Colored pencils or markers
Pencil	Binder clip	Stickers
Colored pencils or markers	Pencil	
Cellophane tape	Cellophane tape	
Optional: Popsicle stick	Optional: Popsicle stick	

## Prep

---

- › Make one sample light-up sign for each workspace.
- › Set up a supply table with materials for decorating the signs.
- › Have copies of the Activity 7 Visual Guide: Light-Up a Sign available.

## Activity Breakdown

---

- › **PART 1:** Welcome and Recap
- › **PART 2:** What Makes a Title Memorable?
- › **PART 3:** Whole-Class Sign Design
- › **PART 4:** Individual Sign Design
- › **PART 5:** Reflect
- › **PART 6:** Preview Next Activity

## PART 1: Welcome and Recap

---



1. Review the session breakdown.
2. Ask students what they recall from the last session. Ask them to share what was easy or challenging about making a simple circuit and what they would do differently next time.



3. Explain that today they will use what they learned about making an LED light up to create a light-up sign for their world. They will:
  - › First, talk about what makes a good book title and come up with an interesting title for their world.
  - › Next, observe you as you make a light-up sign.
  - › Last, design, create, and test a light-up sign to showcase the name of their world.

## PART 2: What Makes a Title Memorable?

---



1. Ask students to share some book titles they love. Capture this brainstorm on the board. Discuss the list by asking:

- › Is there anything these titles have in common?
  - › Are they long? Short?
  - › Do they make the reader feel a certain way or wonder about something?
2. Elicit that strong titles are often short and enticing. They make us curious and include keywords that give us a hint about the story.
  3. Tell students that they will give their world an intriguing “title” and design a light-up sign to display that name. Ask volunteers to share ideas about the parts of signs that could light up (a letter, part of an illustration, etc.).

### PART 3: Whole-Class Sign Design



1. Tell students that you will now demonstrate the steps for making a light-up sign.

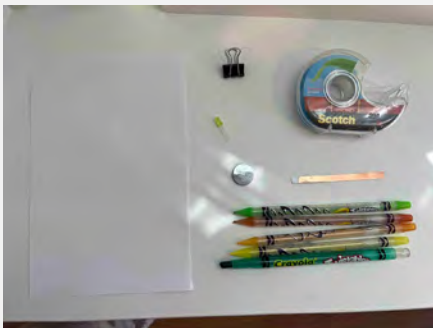

**BEFORE YOU GET STARTED**, gather your supplies:

- › Half sheet of printer paper
- › Binder clip
- › LED
- › Coin cell battery
- › Pencil
- › Colored pencils or markers
- › Copper tape
- › Cellophane tape
- › Optional: Popsicle stick



**FIRST**, fold your paper in half and draw your sign on the front, putting the part you want to light up near a corner.

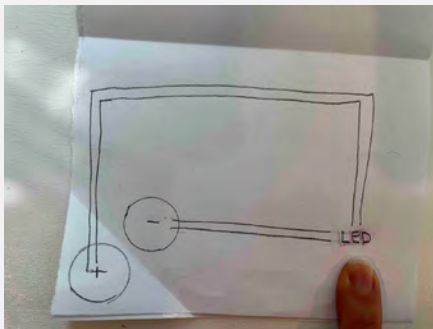

**SECOND**, draw the layout of the circuit, placing the battery in the opposite corner of where the LED will go. Mark the polarity of the battery.



### STICKY SPOT

- Determining the layout of the copper tape, battery, and LED can be tricky. Use self-talk to model ways to approach the challenges students will likely need to figure out.
- Emphasize how important it is to sketch the entire circuit and to label and draw ALL the elements, including where the battery will go, the battery's polarity, and what the layout of the copper tape must be.



**THIRD**, lay the copper tape along the traces, removing small amounts of backing as you go. Smooth out any bumps with your finger (or the side of a Popsicle stick).

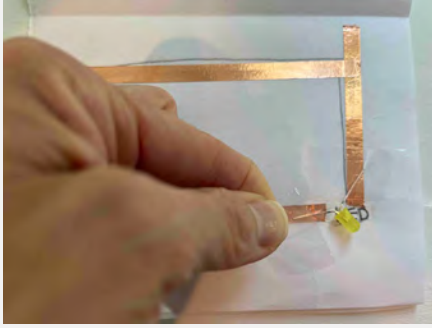

**FOURTH**, use cellophane tape to tape down the leads of the LED.

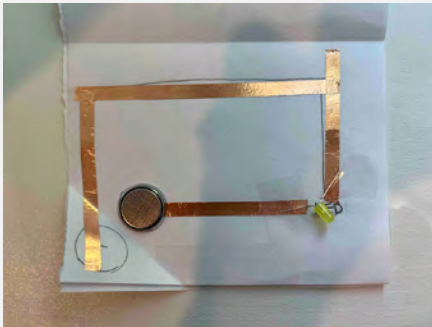

**FIFTH**, place your battery.

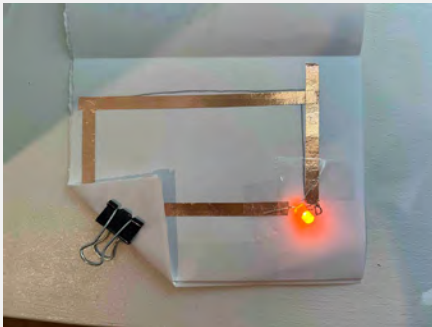

**SIXTH**, fold the corner of the paper over the battery and secure it with the binder clip. Test the circuit. Did your LED light up? If not, double-check that the polarities of the battery, LED, and copper tape match.



**LAST**, close your sign and admire your finished product!

## PART 4: Individual Sign Design

---



1. Distribute journals. Ask students to open to the next blank page and brainstorm as many interesting names for their world as they can think of. Students who feel more productive drawing different versions of signs can do that too.
2. Ask students to choose a name for their world and then sketch what their sign would look like, being sure to mark which element of the sign will illuminate.
3. Ask students to share their final selection with you so you can be sure their design includes ONE element to illuminate.



### MAKING MORE

Some students may be excited to illuminate more than one component of their design, which will require either multiple circuits, or a series or a parallel circuit. [This article](#) explains the differences between these two circuits. [This template](#) can help students understand and explore the layout for a parallel circuit.

4. Give students time to replicate their drawing onto the front side of a folded sheet of printer paper.
5. Have students draw the layout of their circuit on the inside of the folded paper. Remind students to:
  - › draw the traces for the copper tape
  - › include placeholders for the battery and LED
  - › label the components with + and – signs to indicate the polarity of the battery, LED, and copper tape



## ADJUST AND SCALE

- Designing the circuit requires strategic placement of the copper tape and the battery. This can be challenging at any age, but is considerably so for young learners. Consider using [this template](#) with students who need or may prefer added guidance; they can design their sign around the layout provided.
- If children struggle with the fine motor skills required to use copper tape, they can create their sign with just a battery and an LED.

6. Once their designs are complete, have students show their layout to a friend. Another set of eyes can confirm that the polarities of the battery, copper tape, and LED are aligned and labeled.
7. Hand out the sign-making materials, and give students time to work on making their circuits. Tell students that they can either let the light shine through the paper or gently push their LED through the paper to expose it on the front of the sign.
8. Students may add color and decorations to their signs, using the materials at the supply table.

## PART 5: Reflect

---



1. Have students share their signs with the class. Allow time for students to both appreciate one another's work and ask questions about it.
2. Either in their journals or through a class discussion, have students respond to these prompts:
  - What did you make?
  - Was anything particularly challenging?
  - How did what you made compare with what you planned?
  - Did you make changes to your sign once you started working on it? If so, why?

## PART 6: Preview Next Activity

---



In the next activity, students expand their exploration of circuits by integrating vibrating motors into objects made with a set of materials. Distribute the priming document titled [Activity 8 Primer](#), found in the Appendix.



# Activity 8: Make an Object Move ★★☆☆☆

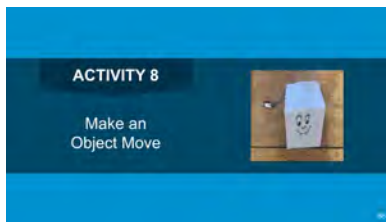

## Session Summary

---

Students continue to explore how circuits work by using batteries and motors to create an object that moves or has a moving part. The challenge-level of this activity is rated three out of five stars.

## Learning Goal and Maker Skills

---

Students learn how to create a circuit that turns on a motor.

## Key Vocabulary

---

- › Circuits
- › Motor
- › Polarity
- › Rotate
- › Shaft
- › Vibrabot
- › Vibration

## Materials

For the Teacher	For Each Student	General Supplies
<p>Vibration motor</p> <p>Craft scissors</p> <p>Coin cell or cylindrical battery</p> <p>Sheet of printer paper</p> <p>Googly eyes</p> <p>Assorted craft materials</p>	<p>Journal</p> <p>Vibration motor</p> <p>Battery</p> <p>Masking tape</p>	<p>Markers</p> <p>Pens</p> <p>Pencils</p> <p><b>For the Demonstration Table</b></p> <p>Butcher paper</p> <p>Vibration motors</p> <p>Coin cell or cylindrical batteries</p> <p>Masking tape</p> <p>Crumpled-up pieces of printer paper</p> <p>Googly eyes</p> <p>Hot glue guns</p> <p>Hot glue sticks</p> <p><b>For the Supply Table</b></p> <p>Scissors</p> <p>A variety of craft supplies, such as:</p> <ul style="list-style-type: none"> <li>› Pipe cleaners</li> <li>› Colored paper</li> <li>› Masking tape</li> <li>› Clothespins</li> <li>› Craft sticks</li> <li>› Rubber bands</li> <li>› Washi tape</li> </ul>

## Prep

---

- › Cover the surface of the demonstration table with butcher paper. Set up the needed materials, including a hot glue gun, several vibration motors, coin cell and cylindrical batteries, masking tape, crumpled-up pieces of printer paper, and googly eyes.
- › Preheat the hot glue guns.
- › Create a sample vibrabot using a motor, a battery, and a variety of craft materials.
- › Use the craft scissors to strip about a half inch of insulation from the motor wires that students will use.
- › Set up a supply table with a variety of craft materials.
- › Have Activity 8 Visual Guide: Light Up a Sign available to students.

## Activity Breakdown

---

- › **PART 1:** Welcome and Recap
- › **PART 2:** Circuits and Motors
- › **PART 3:** Try It!
- › **PART 4:** Reflect
- › **PART 5:** Preview Next Activity

## PART 1: Welcome and Recap

---



1. Review the session breakdown.
2. Ask students what they recall from the last session. Ask them to share what was easy or challenging about making a light-up sign and what they would do differently when making another light-up sign.



3. Explain to students that in this session they will:
  - First, figure out how to make a small motor work.
  - Next, make a *vibrabot*—an object that moves because of the vibrations made by a motor.
  - Last, make an element with a moving part for their world.

## PART 2: Circuits and Motors

---

1. Have students gather around the demonstration table. Give several students a vibration motor and either a coin cell or cylindrical battery, and ask them to figure out how to make the motor vibrate. Once they work out how to do this, have them pass along the motor and battery to others. Ask students:
  - How do you complete the circuit? Does polarity matter?
  - What happens when the motor turns on? What do you feel? Look closely—what do you see? (Students should observe that the motor vibrates and the shaft rotates.)
2. Work with volunteers to make a vibrabot from a vibration motor, a battery, a crumpled-up piece of printer paper, a glue gun, and some googly eyes.
3. As the vibrabot moves, ask students to suggest ways to improve it. Encourage students to consider ways to better secure the wires or to hide the motor or battery. Ask volunteers to execute different suggestions and fine-tune the design.
4. Show your sample vibrabot to the class. Point out where you placed the battery and how to turn it on. Ask students to notice if your object's movement comes from accessories placed on the rotating shaft or from vibration alone.



**BEFORE YOU GET STARTED**, gather:

- › A vibration motor
- › A battery
- › Tape
- › Scissors
- › Folded Paper Design

**NOTE:** If the ends of motor wires are not exposed, watch this 30-second [video](#) on how to strip wires with scissors.

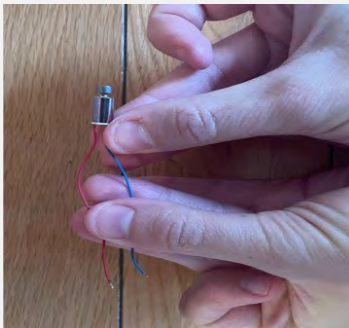

**FIRST**, pinch the exposed part of each stripped wire on a side of the battery. See if the motor begins to vibrate.



**SECOND**, use small pieces of tape to secure each wire on the sides of the battery.

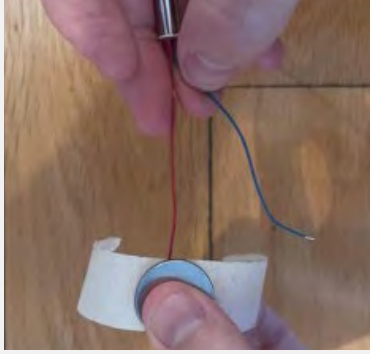

**THIRD**, place the battery on top of the red wire. Press down to secure it to the tape. It doesn't matter which side of the battery you use.

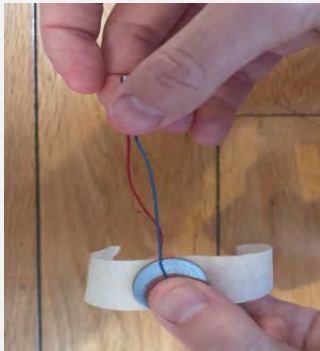

**FOURTH**, place the blue wire on top of the battery. Make sure the thin metal wire is touching the battery.

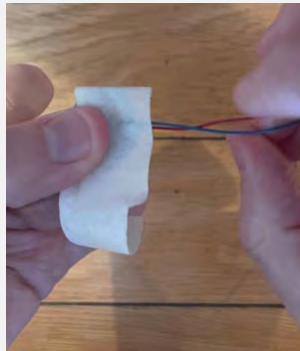

**FIFTH**, fold the tape over the battery. Squeeze to make sure the wires are as connected to the battery as possible. The motor should start vibrating. If it doesn't, remove the tape and try again!



**SIXTH**, make a face on a piece of paper and decide where you want to attach your motor. It's more fun if you try out multiple ways to attach it.

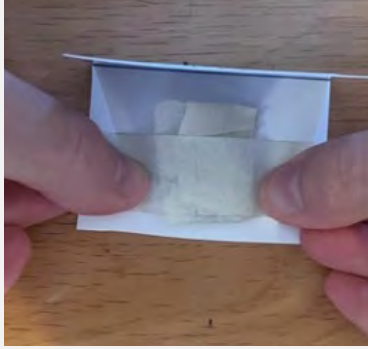

**SEVENTH**, use another piece of tape to secure the motor to the paper design. (It works better if you attach the battery.)

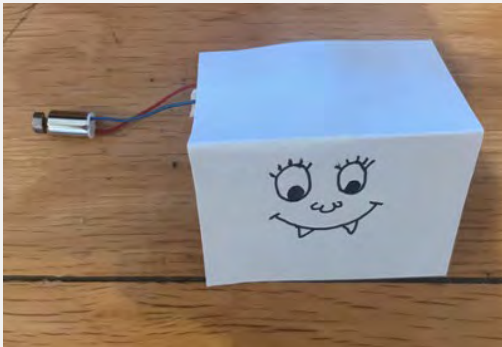

**LAST**, place your design upright and watch how it moves! Reposition the motor if you want to explore other forms of motion.

## PART 3: Try It!



1. Show how the clay creation on slide 88 capitalized on the rotating component of the vibration motor for movement. Point out that one wire is secured against the battery by having it embedded in the clay.

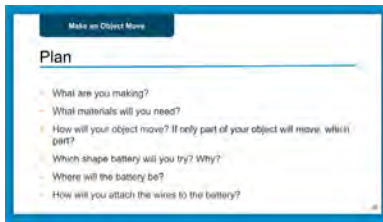

2. Distribute journals, and ask students to refer to their brainstorming charts from Activity 1 to find a person, place, or thing that would be fun to try to make vibrate or move.
3. Ask students to turn to the next blank page in their journal and sketch their chosen item, noting which part will vibrate or move and where the battery will go. Ask students to include a materials list in their plan.
4. Have students share their plan with a partner, using the following questions to guide their conversation:
  - › What are you making?
  - › What materials will you need?
  - › How will your object move? If only part of your object will move, which part?
  - › Which shape battery will you try? Why?
  - › Where will the battery be?
  - › How will you attach the wires to the battery?
5. Ask students to share their materials lists with you. Distribute a motor and the desired battery to each student and provide access to the additional materials from the supply table, reminding students to select items based on their materials lists. If desired materials are not available, guide them in making alternative choices.
6. Give students time to make their plan come to life, creating an object for their world that either vibrates or has a moving part.



### ADJUST AND SCALE

Although this session explores vibration motors, any small motor will work. Older students may appreciate the challenge of DC motors, which can move more substantial accessories; these motors are heavier, require strong bases, and demand creative thinking when it comes to “hiding” them. Depending on their age and ability, students may enjoy this challenge!



## PART 4: Reflect

---



Reconvene the group and invite students to bring their bots, even if they haven't all finished. Ask students to reflect on the day's session. Consider discussing or having them write responses to these prompts:

- › What did you make?
- › How did you make it?
- › What tools did you use? How did you use them?
- › What was challenging? What was easy?
- › Did anything surprise you?
- › What will you do next?

## PART 5: Preview Next Activity

---

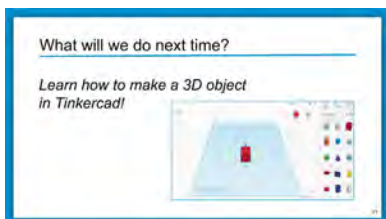

In the next activity, students explore Tinkercad, a 3D modeling software. Distribute the priming document titled [Activity 9 Primer](#), found in the Appendix.

# Activity 9: Make a Virtual Object ★★☆☆☆



## Session Summary

Students learn introductory 3D modeling software skills using Tinkercad, a free Web-based program. The challenge level of this activity is rated five out of five stars.

## Learning Goal and Maker Skills

Students learn fundamental 3D modeling software features, including stretching, rotating, grouping, creating holes, lifting, and changing color.

## Key Vocabulary

- › 3D modeling
- › Dimensions
- › Grouping
- › Lifting
- › Stretching

## Materials

For the Teacher	For Each Student	General Supplies
Computer with Internet access Bridge block Cylinder block	Tablet or laptop Journal	Markers Pens Pencils Optional: Computer mice Optional: 3D printer

## Prep

---

1. Create an Educator Account on Tinkercad:

<b>FIRST</b>	Log in to <a href="https://tinkercad.com">tinkercad.com</a> and select "Sign Up."
<b>SECOND</b>	Select <i>Educators Start Here</i> .
<b>THIRD</b>	Click through to sign up via email.
<b>FOURTH</b>	Select <i>Create New Class</i> and name it: Maker Club.
<b>FIFTH</b>	Select your new class.
<b>SIXTH</b>	Select <i>Add Student</i> . This is where you would add students' names and give them a "nickname" in case there are duplicate names.
<b>SEVENTH</b>	Select <i>Class Code</i> . This is the code your students use. Print out a copy for each student if possible. (Students will also log in to <a href="https://tinkercad.com">tinkercad.com</a> , but they will select <i>Students Join a Class</i> when signing up. They will enter the class code and their name or nickname.)

2. Make sure you have the printed class codes available for when the students log in to Tinkercad. Tinkercad allows you to track student progress and projects. It also allows students to create accounts without email addresses.
3. If possible, gather computer mice for the students who will use laptops.
4. Have copies of the [Activity 9 Visual Guides](#) Parts 1–4 available.

## Activity Breakdown

---

- › **PART 1:** Welcome and Recap
- › **PART 2:** Logging In to Tinkercad
- › **PART 3:** Playing with Tinkercad
- › **PART 4:** Learning Techniques
- › **PART 5:** Reflect
- › **PART 6:** Preview Next Activity

## PART 1: Welcome and Recap

---



1. Review the session breakdown.
2. Ask students to recall what they did in the last session. What did they make?



3. Explain that today they will learn the basic features of Tinkercad, an online 3D modeling software. Ask:
  - › Has anyone has used Tinkercad or any other 3D modeling software before?
  - › What do you think the software lets you do? Why would you want to use it?
4. Explain that today, students will:
  - › First, log in to the software.
  - › Next, explore Tinkercad on their own.
  - › Last, learn four skills to make a 3D shape.
5. If 3D printing is an option, explain that students can PRINT mini versions of what they build to include in their world.

## PART 2: Logging In to Tinkercad

---

1. Distribute journals and the printed class codes. Encourage students to staple or copy the codes in their journals. Tell students any nicknames you selected for them, and have them write those in their journals as well.

2. Students will log in to [tinkercad.com](https://tinkercad.com) and select “Students Join a Class.” Next, they will type in the class code and their name or nickname.
3. Once logged in, have them select “Create New Design.”
4. Tell students that if they have a tablet or computer at home, they can use this login to work on their model or a new design there as well.

## PART 3: Playing with Tinkercad

---



1. Give students 5–10 minutes to play around with Tinkercad. After that time is up, ask them to push their laptops forward and pause on using the software. It might be helpful to ask students to close the laptops during discussion to avoid distractions.
2. Ask:
  - › What did you discover?
  - › Did anyone make anything? What was it, and how did you figure it out?
  - › What else did you notice?
3. Ask students to click the Tinkercad logo in the top left corner  and then click “Create New Design.”
4. Tell students that they will now begin learning key tools for creating 3D models on Tinkercad.

## PART 4: Learning Techniques

---

1. Show students the bridge foam block.
2. Explain that Tinkercad has many basic shapes, but is missing the bridge shape. Explain that they will learn to create the bridge shape on Tinkercad using some basic shapes and tools.
3. Tell students that once they know how to make the bridge, they will have several of the skills needed to make more complex models.

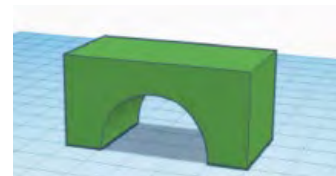

4. Provide an overview of the icons on the left side.

## Icon Overview

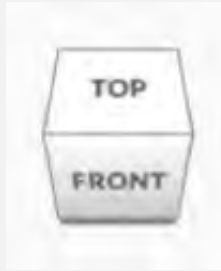

**VIEW CUBE:** Changes the view and/or perspective. You can click the different angles of the cube, or click and hold the cube to rotate the view.

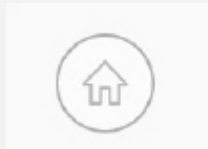

**HOME:** Resets the view to its default position.



**ZOOM:** Zooms in and out. + lets you look more closely at your designs, and – lets you look from farther back.



5. Begin walking students through building the bridge shape. First, they will stretch the Box into a rectangular prism by setting new dimensions. They will then use the Round Roof shape to cut a hole in the prism. Have students follow these steps:



## ADJUST AND SCALE

Students who prefer to do this work on their own can use the [Activity 9 Visual Guide, Part 1: Stretching](#) to guide them.

### Skill 1: Stretching by Setting Dimensions



**FIRST**, click the cube shape on the Basic Shapes list.

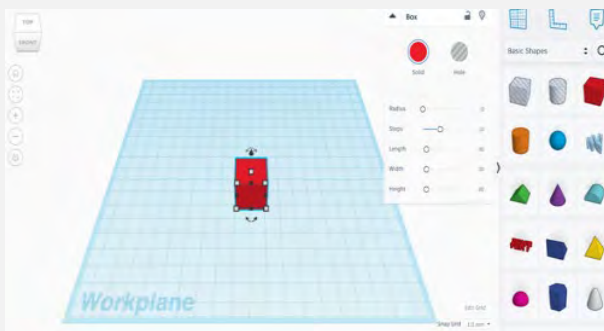

**SECOND**, move the cursor to the center of the blue workplane and click to place the cube.

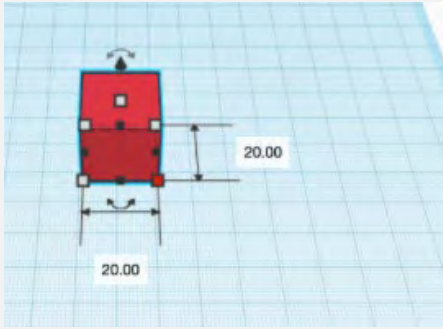

**THIRD**, click the tiny white square at the right side of the cube. It should turn red and show the dimensions of the cube in millimeters.

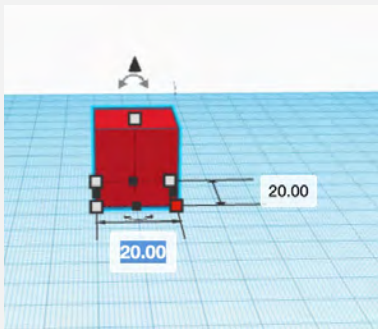

**FOURTH**, click on the box in the front center that says "20.00." This box controls the width of the shape.

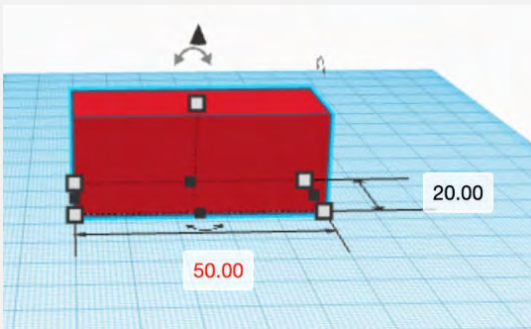

**FIFTH**, type 50.00 in the box and press "Enter."

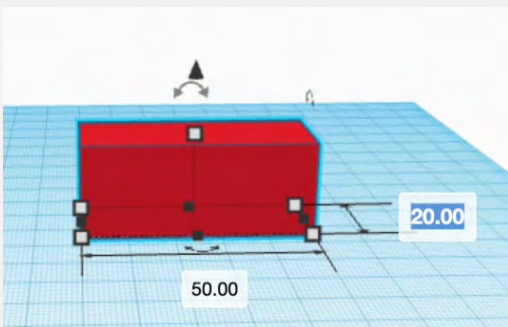

**SIXTH**, click on the box on the right side that says "20.00." This box controls the length of the shape.



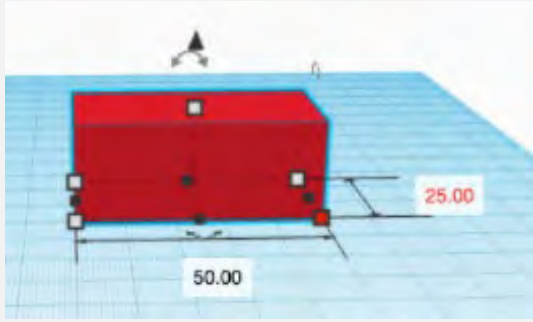

**SEVENTH**, type 25.00 in the box and press "Enter."

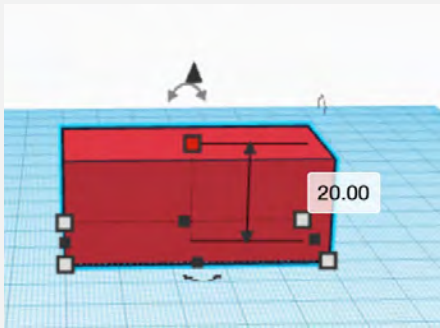

**EIGHTH**, click the white square on the top of the shape. It should turn red.

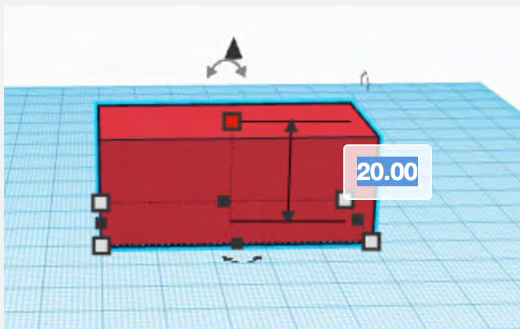

**NINTH**, click on the box on the front right side that says "20.00." This box controls the height of the shape.

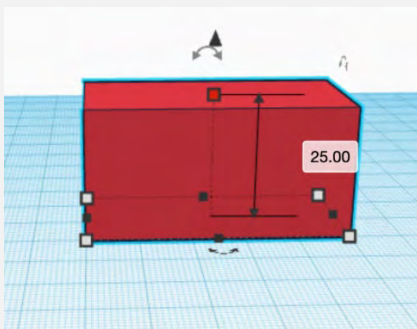

**LAST**, type 25.00 and press "Enter."

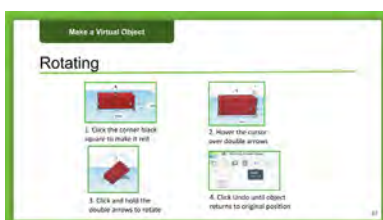

6. Explain that students might need to rotate the shape to look at its different sides as they build. Students can practice rotating by following these steps:



### ADJUST AND SCALE

Students who are able to do this work on their own can use the [Activity 9 Visual Guide, Part 2: Rotating](#) to guide them.

### Skill 2: Rotating

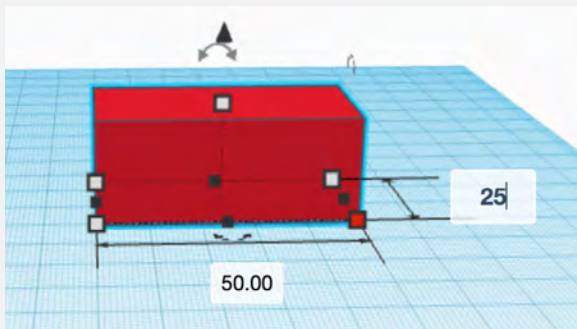

**FIRST**, click the white box in the right corner, making it turn red.

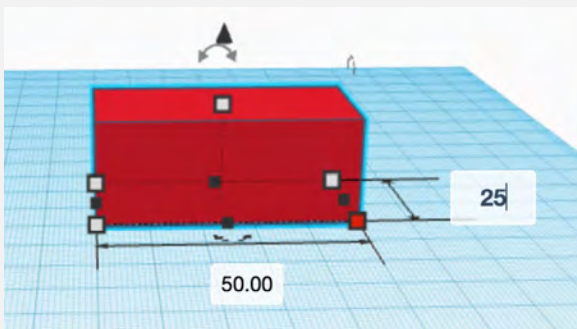

**SECOND**, notice the double-sided curved arrows that appear around the shape.

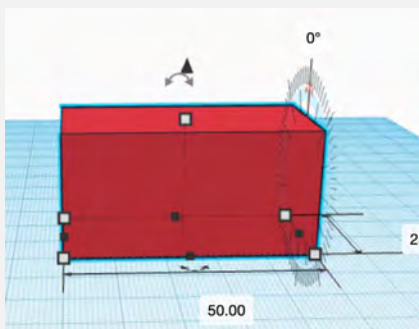

**THIRD**, hover the cursor over each curved arrow. This will show you the directions in which you can rotate the shape. There are three ways to rotate it!

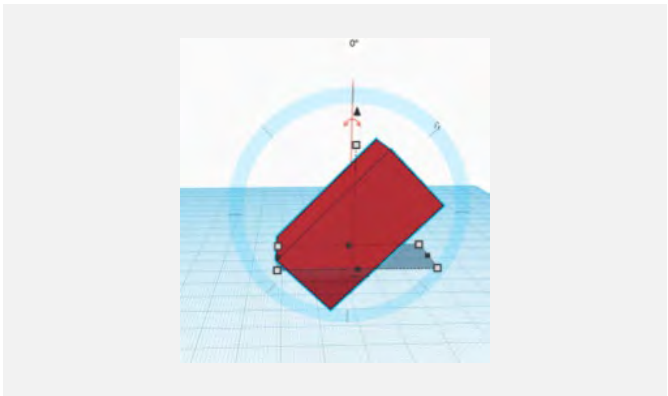

**FOURTH**, click on one of the rotation icons, and experiment with rotating the shape.

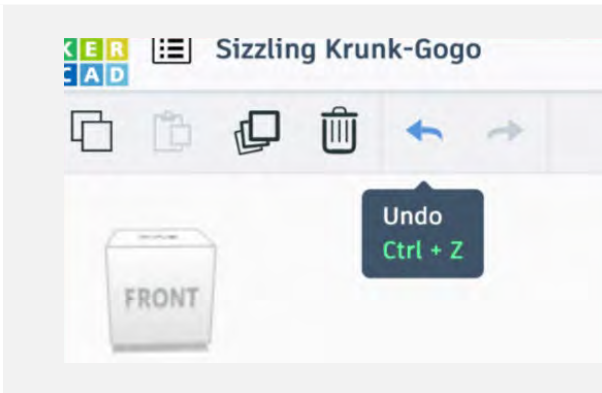

**LAST**, press the left-facing arrow at the top left of the build plate to undo any rotations and return the shape to its original position. You might need to press undo several times.



7. Explain that the next step is to create an arch to make the bridge shape. They will position a Round Roof shape through their stretched box and then “group” the shapes, which “cuts a hole.” Students should follow these steps:



### ADJUST AND SCALE

Students who prefer to do this work on their own can use the [Activity 9 Visual Guide, Part 3: Creating Holes and Grouping](#) to guide them.

### Skill 3: Creating Holes and Grouping

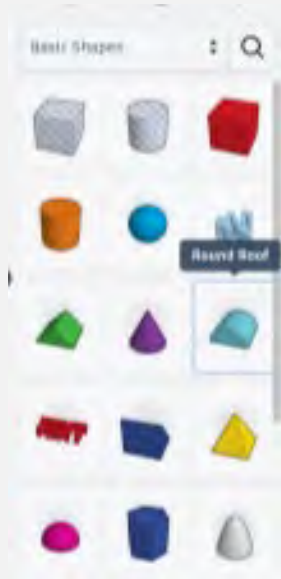

**FIRST**, select the Round Roof shape from the Basic Shapes list.

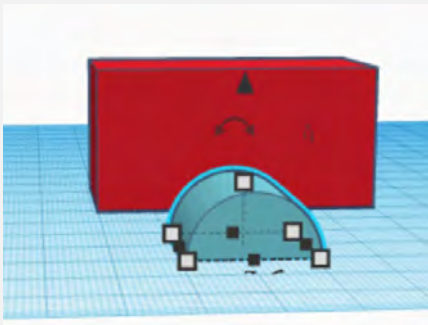

**SECOND**, place the Round Roof in front of the "red box."

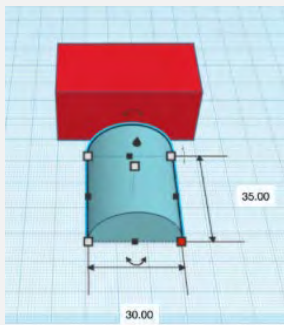

**THIRD**, set the width of the Round Roof to 30.00 and the length to 35.00.

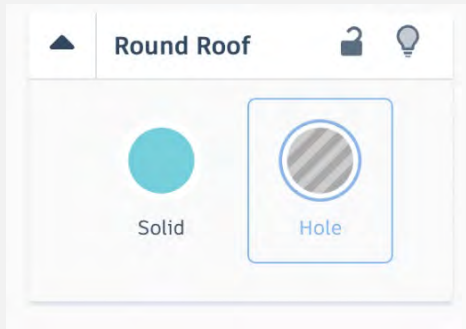

**FOURTH**, select the Hole icon. A shape can be a solid or a hole. A hole cuts shapes away from solids. The Round Roof will remove an arch shape from the red box, creating the bridge.

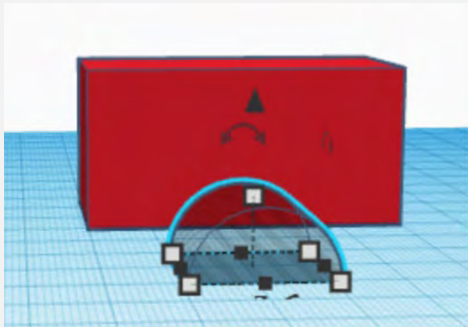

**FIFTH**, make sure the Round Roof turns transparent gray. Holes are transparent gray.



**SIXTH**, click the Top view on the view cube.

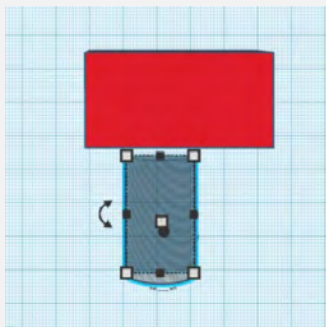

**SEVENTH**, make sure you have a bird's-eye view of your shapes.

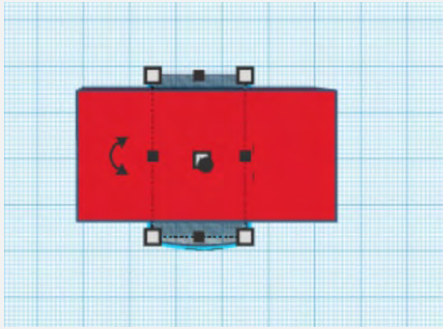

**EIGHTH**, use the arrows on your keyboard to move the hole so it is in the center of the red box. The hole should go all the way through the red box, creating a full bridge.

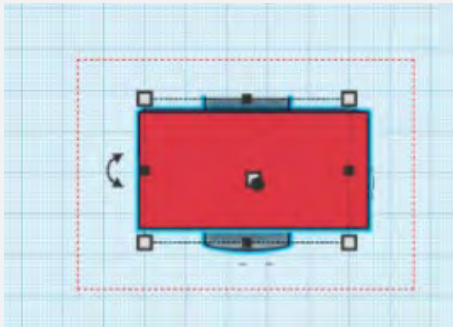

**NINTH**, click outside the shape and drag a bounding box around both shapes. This will select both shapes. Selected shapes are highlighted in blue.

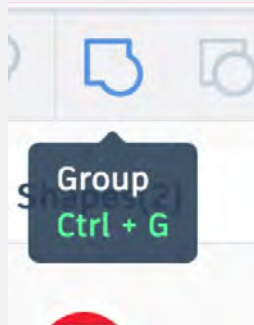

**TENTH**, click the Group icon. Group is how we combine shapes and create holes.

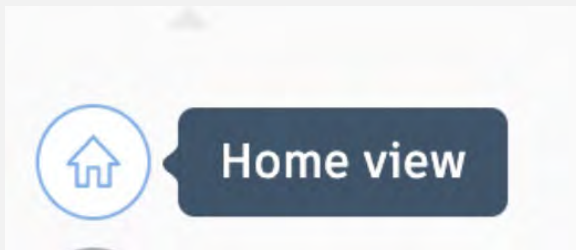

**LAST**, click Home view to reset the view.



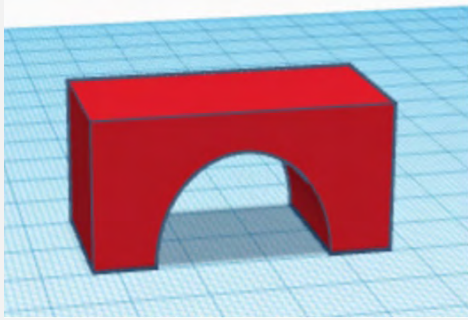

**CONGRATULATIONS!** You made a bridge block.

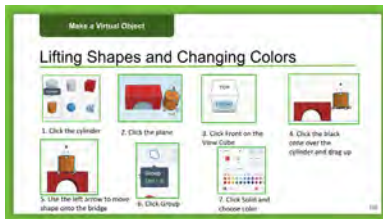

8. Tell students that they now have most of the basic tools needed to use Tinkercad. The last feature that will be helpful for transferring their block structures into Tinkercad is lifting. As they practice this last skill, they will also learn how to change the color of their blocks. Ask students to follow these steps to stack a cylinder block on top of a bridge shape.

#### Skill 4: Lifting Shapes and Changing Colors



#### ADJUST AND SCALE

Students who prefer to do this work on their own can use the [Activity 9 Visual Guide, Part 4: Lifting Shapes and Changing Colors](#) to guide them.



**FIRST**, select the Cylinder from the Basic Shapes list.

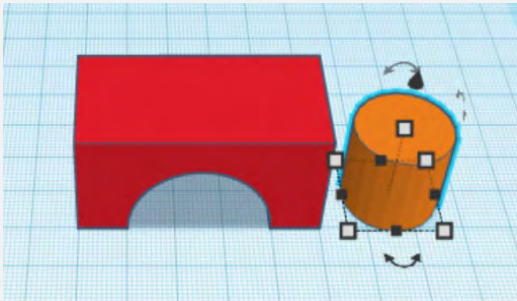

**SECOND**, place the Cylinder next to the bridge.



**THIRD**, select the Front view on the View Cube.





**FOURTH**, click on the cone shape above the Cylinder and drag it upward. This will lift the shape.

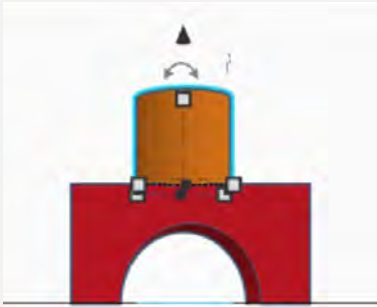

**FIFTH**, use the computer arrows to move the Cylinder to the left so it stacks on top of the bridge. Adjust the height of the lift as needed.

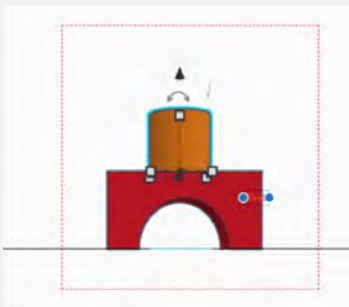

**SIXTH**, you will now group the shapes. Grouping lets us turn multiple shapes into one shape. Click outside the shapes and drag a bounding box around both shapes.

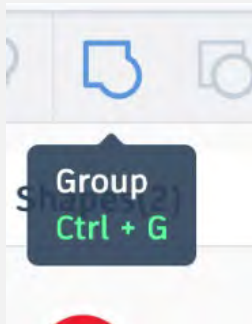

**SEVENTH**, select "Group" to combine the shapes.

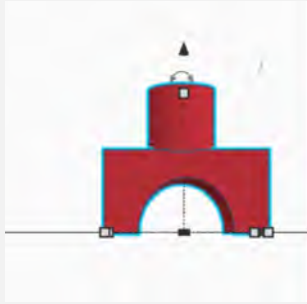

**EIGHTH**, you will now change the color!

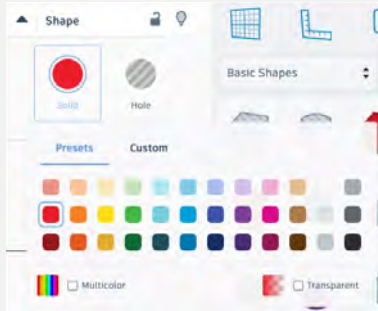

**LAST**, select "Solid," and then choose a color for your structure.



**CONGRATULATIONS!**



## MAKING MORE

1. For students who would like more practice with Tinkercad, there are other tutorials available at [tinkercad.com/learn](https://tinkercad.com/learn).
2. Students who are able and interested can challenge themselves further by recreating their block sculptures from Activity 5: Build with Blocks in Tinkercad. A few notes for facilitation:
  - › Students' measurements do not need to be exact. An approximation will do.
  - › Encourage students to constantly check different views to make sure shapes are touching each other. It is very easy for shapes to wander!
  - › If students numbered their blocks, it may be helpful to create the shapes for the virtual version of their sculpture in the same order in which they built them with physical blocks.
3. If you have access to a 3D printer and, as importantly a person who has some experience with exporting files and troubleshooting the printing process, students can see their virtual object come to life in a new way.

## PART 5: Reflect

---

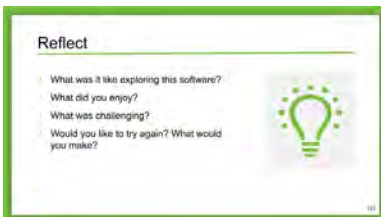

Either in their journals or through a class discussion, have students respond to these prompts:

- › What was it like exploring this software?
- › What did you enjoy?
- › What was challenging?
- › Would you like to try using the software again? What would you like to make?

## PART 6: Preview Next Activity

---



In the next activity, students inventory the items they have made, select which they'd like to include in their worlds, determine which they'd like to refine, and decide what additional items to make. Distribute the priming document titled [Activity 10 Primer](#), found in the Appendix.



### STICKY SPOT

Depending on the amount of time available, students may only be able to inventory what they have and not be able to create new objects or tweak current ones. Provide students with advance notice about the number of remaining sessions to help pace completion of their work and help students prioritize revisions or new creations.

# Activity 10: Refine and Finish Worlds



## Session Summary

Students inventory the items they have made, select which they'd like to include in their world, determine which they'd like to refine, and decide what additional items they want to include in their world. The challenge-level of this activity will vary depending on the tools required and the complexity of desired outcomes.

**Note:** The number of sessions you schedule for this work will depend on the time you have available.

## Materials

For Each Student	General Supplies
Journal	Markers
Pencil	Pens
Final Inventory and Planning Sheet	Pencils
	Paper
	Clay
	Cardboard
	LEDs
	Copper tape
	Coin cell batteries
	AA or AAA batteries
	Motors
	Wire cutters
	Hot glue guns
	Hot glue sticks
	Butcher paper
	Assorted craft supplies

## Prep

---

- › Make a copy of the Final Inventory and Planning Sheet for each student.
- › Set up a hot glue gun station.

## Activity Breakdown

---

- › **PART 1:** Welcome and Recap
- › **PART 2:** Inventory and Planning
- › **PART 3:** Build On!
- › **PART 4:** Reflect
- › **PART 5:** Preview the Showcase

## PART 1: Welcome and Recap

---



1. Review the session breakdown.
2. Ask students what they recall from the last Maker Club session. Ask them to share what was easy or challenging about using Tinkercad.



3. Explain that during the rest of the Maker Club sessions, they will focus on completing their worlds for the showcase. Students will:
  - › First, categorize the objects they've made so far, deciding what is ready for the showcase; what needs to be fixed, tweaked, or added to; and if there are any new items they want to make.

- Next, decide if they want to create new items and, if so, sketch their plans or designs and list the materials they need.
- Last, start executing their plan for fixing objects and/or creating new ones.

## PART 2: Inventory and Planning

---



1. Distribute a copy of the Final Inventory and Planning Sheet to each student. Explain that they will use this sheet to record what they have ready for the showcase, what items they may want to adjust, and if time allows, what new items they want to make.
2. Distribute students' storage boxes and give them time to go through them.
3. Give students time to complete the planning sheet. Suggest that they draw or name items in the NEW section and be sure to list or draw the supplies they will need as well. Ask them about additional items that will help make the world they envisioned come to life. Encourage students to refer to their original brainstorming chart if they need inspiration.

## PART 3: Build On!

---

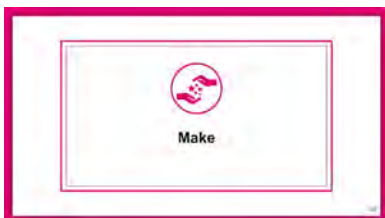

1. Invite students to gather materials from the supply table for their first item and get to work.
2. As students work, ask them to staple their Final Inventory and Planning Sheet into their journals.



## ADJUST AND SCALE

Getting to this point is exciting and can also be overwhelming. If students are struggling, invite them to take a break. They might spend some time visiting other students' work areas to get inspired and notice the objects, materials, and design choices their classmates are making. They might also draw additional diagrams of the world they will get back to working on when they are ready.

## PART 4: Reflect

---

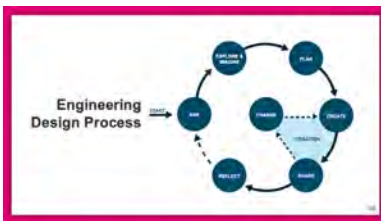

**Note:** From this point forward, students are iterating—creating, sharing, and tweaking their objects. While it's a busy and exciting time, students can also benefit from pausing and reflecting.

Either in their journals or through a class discussion, provide opportunities for students to consider these questions:

- › Where are you in the EDP?
- › Would you like to share what you are working on for feedback or for help troubleshooting a challenge?
- › What additional materials do you need? How much more time do you need? What are your priorities? What could you remove from your “to do” list so you don’t run out of time?



## PART 5: Preview the Showcase

---



Remind students that their work in Maker Club will conclude with a public showcase. They will organize their worlds for display, practice interacting with visitors, and share their creations with the public.

# Conclusion: Host a Showcase

## Session Summary

---

Students organize their worlds for display, prepare for and practice interacting with visitors, and share their creations with visitors during a public showcase.

## Materials

---

For the Teacher	For Each Student	General Supplies
Images taken during the club for a slideshow Optional: Chart paper and markers	Maker Badge Journal	Tape Badge-making supplies Markers

## Prep

---

- › Distribute the [Showcase invitation letter](#) to families and community members.

**Note:** Some students may want to create their own Maker Badges—see Making More in Part 2.

- › Set up a display area for each student's world. This could be on the floor or on tables or desks.
- › Create a slideshow of images taken during the club to run during the event.

## Activity Breakdown

---

- › **PART 1:** Welcome
- › **PART 2:** Prepare
- › **PART 3:** Celebrate!

## PART 1: Welcome

---

Tell students that today is the day to show off their amazing worlds to their community! They will:

- › First, talk about and practice ways to engage with visitors.
- › Next, set up their worlds for display.
- › Last, host visitors and share their worlds with them.

## PART 2: Prepare

---

1. Brainstorm a list of ways that students could engage with visitors, and write their ideas on the board or chart paper. If students get stuck, offer examples such as:
  - › Talk about the name of their world and their inspiration for choosing it.
  - › Show their favorite parts of their world, and discuss how they made them.
  - › Have some spare batteries and motors or simple circuits on hand for visitors to experiment and play with—students can serve as facilitators to their guests' experiences.
  - › Invite visitors to look at their journals (if students are comfortable sharing them) to learn about their planning process—as well as how they made their journal!
  - › Ask visitors what questions they have about the world they are looking at.



### ADJUST AND SCALE

Sharing one's work with others can be nerve-racking and can make having an open-ended exchange difficult. Consider preparing questions that students can ask visitors to start a conversation such as: What do you notice? What do you like? What are you curious about?

2. Allow time for students to arrange their world in the display area. Encourage students to include their journal as part of their display if they are willing to share it.



## MAKING MORE

Encourage students to make a badge to wear at the showcase out of whatever materials inspire them. You can also offer the [Maker Badge Template](#) for students to use. The [Materials List](#) includes a link to a button-making kit as an optional supply.

3. Give students time to practice engaging with visitors. Have them take turns at each other's worlds and practice responding to each other's questions.

## PART 3: Celebrate!

---

1. Run the slideshow. You or your students can point out examples of students engaging in the Engineering Design Process and the hard fun that went into creating their worlds.
2. Enjoy the makers' accomplishments!

# Appendix

## General Resources

1. [Family Permission Letter](#)
2. [Materials List](#)
3. [Donations Letter](#)
4. [Donations Flyer](#)
5. [Engineering Design Process Graphic](#)
6. [IDEAS Research Summary](#)

## Activity 1: Imagine a World

1. [Activity 1 Primer: Imagine a World](#)
2. [World Inventory Chart Template](#)

## Activity 2: Make a Journal

1. [Activity 2 Primer: Journal Making](#)
2. [Visual Guide: Sewn Journal, Part 1 – Folding Pages](#)
3. [Visual Guide: Sewn Journal, Part 2 – Making Holes](#)
4. [Visual Guide: Sewn Journal, Part 3 – Threading the Needle](#)
5. [Visual Guide: Sewn Journal, Part 4 – Sewing the Binding](#)
6. [Visual Guide: Wrapped Journal](#)

### Activity 3: Work with Clay

1. [Activity 3 Primer: Work with Clay](#)
2. [Visual Guide: Clay, Part 1 – Pinching](#)
3. [Visual Guide: Clay, Part 2 – Coiling](#)

### Activity 4: Work with Cardboard

1. [Activity 4 Primer: Work with Cardboard](#)
2. [Visual Guide: Cardboard, Part 1 – Scoring](#)
3. [Visual Guide: Cardboard, Part 2 – Cutting](#)
4. [Visual Guide: Cardboard, Part 3 – Creating Curves](#)
5. [Visual Guide: Cardboard, Part 4 – Creating Slots](#)

### Activity 5: Build with Blocks

1. [Activity 5 Primer: Build with Blocks](#)

### Activity 6: Light Up an LED

1. [Activity 6 Primer: Light Up an LED](#)
2. [Visual Guide: Light Up an LED: Square](#)
3. [Visual Guide: Light Up an LED: Straight Lines](#)
4. [Simple Circuit Template: Square](#)
5. [Simple Circuit Template: Straight Lines](#)

## ACTIVITY 7: Make a Light-Up Sign

1. [Activity 7 Primer: Make a Light-Up Sign](#)
2. [Visual Guide: Make a Light-Up Sign](#)

## ACTIVITY 8: Make an Object Move

1. [Activity 8 Primer: Make an Object Move](#)
2. [Visual Guide: Make an Object Move](#)

## ACTIVITY 9: Make a Virtual Object

1. [Activity 9 Primer: Make a Virtual Object](#)
2. [Visual Guide: Virtual Objects Part 1 – Stretching by Setting Dimensions](#)
3. [Visual Guide: Virtual Objects Part 2 – Rotating](#)
4. [Visual Guide: Virtual Objects Part 3 – Creating Holes and Grouping](#)
5. [Visual Guide: Virtual Objects Part 4 – Lifting Shapes and Changing Color](#)

## ACTIVITY 10: Refine and Finish Worlds

1. [Activity 10 Primer: Refine and Finish Worlds](#)
2. [Final Inventory and Planning Sheet](#)

## PREPARING FOR AND HOSTING A SHOWCASE

1. [Showcase Invitation](#)
2. [Maker Badge Template](#)

# Supplemental Documents



# Visual Guides

## Activity 2 Visual Guide: Sewn Journal, Part 1 – Folding Pages

Demonstrate how to fold the pages, asking students to follow the steps as you do each one:



**FIRST**, fold a piece of cardstock in half along the long side.



**SECOND**, use the edge of a Popsicle stick to push along the fold and make it crisp.



**THIRD**, fold 10 pieces of printer paper in half at once.



**FOURTH**, use the edge of a Popsicle stick to push along the fold and make it crisp.

## Activity 2 Visual Guide: Sewn Journal, Part 1 – Folding Pages



**FIFTH**, place the folded printer pages inside the folded cardstock.

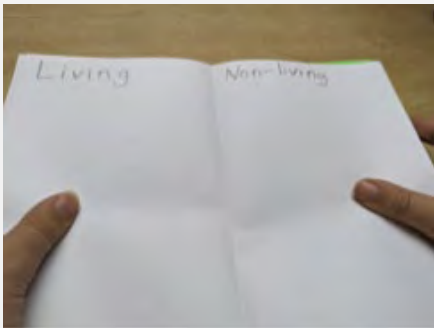

**LAST**, open the pages and insert your brainstorming chart in the center.

## Activity 2 Visual Guide: Sewn Journal, Part 2 – Making Holes



**BEFORE YOU GET STARTED**, gather your supplies:

- › The stack of folded journal pages
- › 4 binder clips
- › Pencil
- › Foam block
- › Nail
- › Hammer



**FIRST**, attach a binder clip to each corner of the stacked journal pages.



**SECOND**, use a pencil to mark holes down the center crease, about an inch apart.

## Activity 2 Visual Guide: Sewn Journal, Part 2 – Making Holes

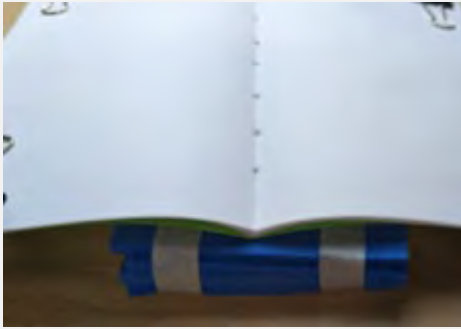

**THIRD**, place the journal pages onto the foam block.



**FOURTH**, place the nail on the first mark. Hold it in place by pinching it near the bottom.



**FIFTH**, use the hammer to gently tap the head of the nail. The nail will go through the pages and just into the top foam.

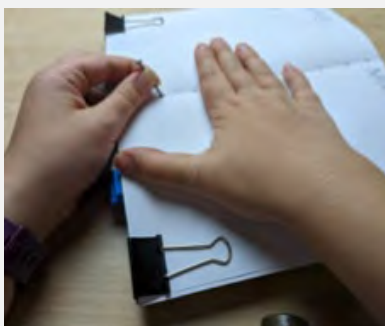

**SIXTH**, remove the nail by pulling it out with one hand while pushing down on the papers with the other.

**LAST**, repeat steps 6 and 7 until you have made a hole at each pencil mark.

## Activity 2 Visual Guide: Sewn Journal, Part 3 – Threading the Needle



**BEFORE YOU GET STARTED**, gather your supplies:

- › The stack of journal pages with holes down the spine
- › Embroidery thread
- › Threader
- › Embroidery needle
- › Scissors



**FIRST**, cut off approximately 25" of embroidery thread.

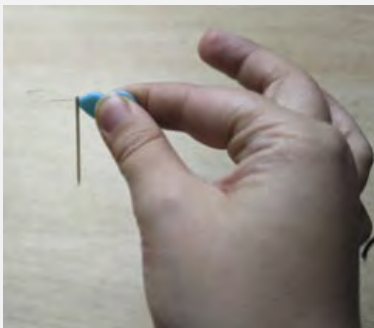

**SECOND**, push the threader all the way through the eye of the needle.

## Activity 2 Visual Guide: Sewn Journal, Part 3 – Threading the Needle



**THIRD**, loop the thread through the threader.

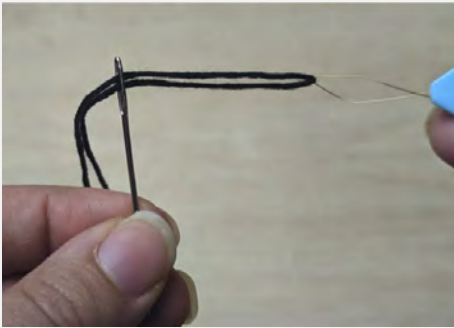

**FOURTH**, pull the needle off of the threader and onto the thread.



**FIFTH**, line up the two ends of the thread.

## Activity 2 Visual Guide: Sewn Journal, Part 2 – Threading the Needle



**SIXTH**, gently wrap the thread around your index finger and make an X, holding the tail with your thumb and middle finger.



**LAST**, place the needle underneath and through the X while continuing to hold the tail with your thumb and middle finger. Pull the threaded needle slowly to make a knot.



## Activity 2 Visual Guide: Sewn Journal, Part 3 – Sewing the Binding



**FIRST**, start from the back of the journal and put the needle in the first hole.

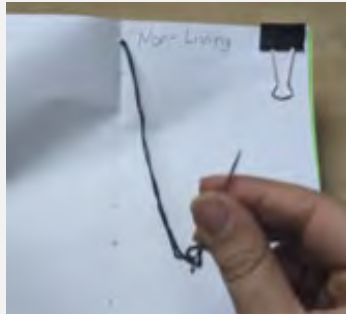

**SECOND**, flip over the journal and pull the needle and thread all the way through.

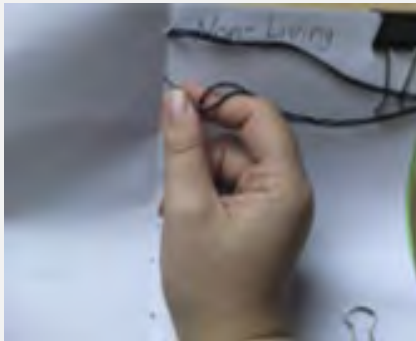

**THIRD**, place the needle in the next hole.

## Activity 2 Visual Guide: Sewn Journal, Part 3 – Sewing the Binding



**FOURTH**, flip over the journal and pull the needle and thread all the way through.

Repeat this pattern—inserting the needle in the next hole, flipping over the journal, and pulling the needle and thread through the hole—all the way to the last hole.



**LAST**, when you get to the end, loop the thread through itself a couple of times to make knots, and cut off the excess with scissors. Remove the binder clips.



**If you'd like to make your journal binding even stronger, try this optional last step.**

When you get to the last hole and pull the needle and thread through, bring the needle and thread over the top of the journal, and push it through the same hole from the opposite side. This will create a stitch that loops over the top.

Start sewing in the opposite direction, inserting the needle in the next hole, flipping over the journal, and pulling the needle and thread through until you get to the hole where you began.

Loop the thread through itself a couple of times to make knots, and snip off the excess with scissors.

Remove the binder clips.

## Activity 2 VisualGuide: Wrapped Journal



**FIRST**, fold a piece of cardstock in half along the long side.



**SECOND**, use the edge of a Popsicle stick to push along the fold and make it crisp.



**THIRD**, fold 10 pieces of printer paper in half at once.



**FOURTH**, use the edge of a Popsicle stick to push along the fold and make it crisp.

## Activity 2 VisualGuide: Wrapped Journal



**FIFTH**, put the folded printer paper and the brainstorming chart inside the folded cardstock.



**SIXTH**, open all pages at the middle page and attach binder clips to each corner.



**SEVENTH**, cut a triangle-shaped notch around the top and bottom creases of the journal, making sure to cut through all the pages.



**EIGHTH**, cut a 48" long piece of embroidery thread. Lay the first 12" down on your work surface and place the journal on top of it, centering the thread in the notches.

## Activity 2 VisualGuide: Wrapped Journal



**NINTH**, bring the cut end of the thread toward the top notch and make a knot.

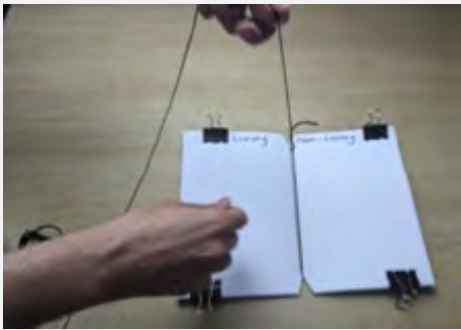

**TENTH**, wrap the embroidery thread around the journal, placing the thread in the notches at the top and bottom. Wrap the thread around the journal at least four times.



**ELEVENTH**, cut the embroidery thread, leaving a few extra inches at the end.

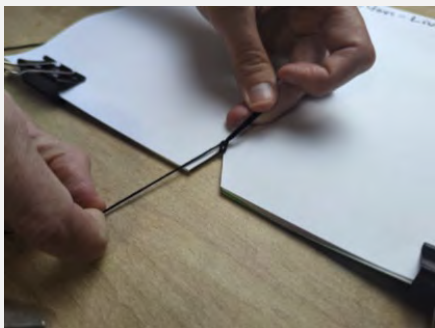

**TWELFTH**, tie a few knots by looping the embroidery thread underneath the wrapped binding.

## Activity 2 VisualGuide: Wrapped Journal



**LAST**, remove your binder clips and close the journal.

## Activity 3 Visual Guide: Clay, Part 1 – Pinching



**BEFORE YOU GET STARTED**, gather your supplies:

- › Clay
- › A clay knife



**FIRST**, place your palm on a chunk of clay, press down, and move your hand in a circular motion to roll the clay into a ball.



**SECOND**, press your thumb into the center of the clay ball, about halfway through.



**THIRD**, use your fingers to pinch around the edges of the clay. You want it to begin looking like a cup.



### Activity 3 Visual Guide: Clay, Part 1 – Pinching



**FOURTH:** Place both thumbs in the cup and pinch the edges between your thumbs and other fingers to continue thinning out the sides of the cup.



**LAST,** smooth the edges with your thumb. What can you make using this shape?

## Activity 3 Visual Guide: Clay, Part 2 – Coiling



**FIRST**, select a ball of clay and place your palm on top of it.

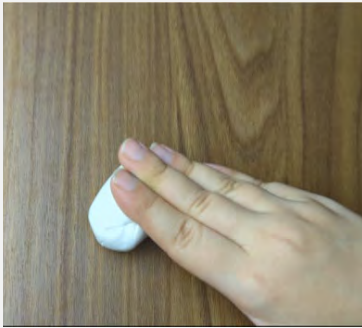

**SECOND**, lightly press down and move your hand back and forth, rolling the ball underneath your hand so it starts to get longer.

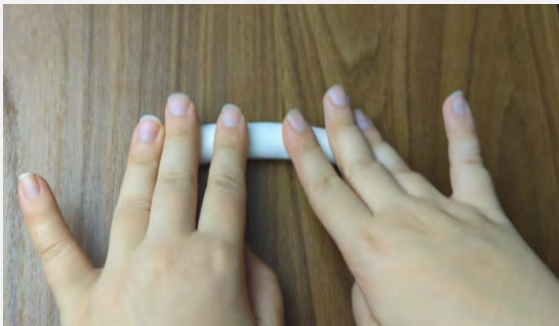

**THIRD**, use the tips of all your fingers to keep rolling the clay, moving your hands away from each other just slightly with each roll. Try to keep the cylinder from breaking. Your goal is to roll it the width of a finger.



**FOURTH**, smooth any cracks with your fingers.

### Activity 3 Visual Guide: Clay, Part 2 – Coiling



**FIFTH**, make another roll. Your two rolls should be the same size.

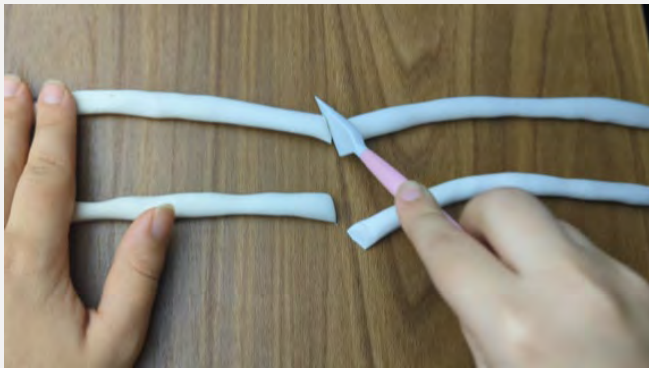

**SIXTH**, cut both rolls in half.



**SEVENTH**, roll one of the halves into a spiral.



**EIGHTH**, smooth over the grooves of your spiral with your finger. This is going to be the base of a cup.

## Activity 3 Visual Guide: Clay, Part 2 – Coiling



**NINTH**, select one of your rolls and wrap it around the edge of your base. If it is too long, you can use your knife to cut it. This is your first coil.



**TENTH**, select another roll and coil it on top of the first. You want the ends to meet on the opposite side of where the ends of the first coil meet to increase stability.



**ELEVENTH**, keep building up your cup and adding coils! You may roll more clay as needed.



**LAST**, choose if you want to leave your cup coiled. If not, use your finger to smooth out the joints between the coils.

## Activity 4 Visual Guide: Cardboard, Part 1 – Scoring



**BEFORE YOU GET STARTED**, gather your supplies:

- › Protective gloves
- › A piece of cardboard
- › A cardboard cutter
- › A pencil
- › A ruler
- › Tape



**FIRST**, put on your gloves and then use the pencil and ruler to draw a straight line in the center of the cardboard.



**SECOND**, place the blade of the cardboard cutter at the top of the line and press down gently so it pierces just the top layer of cardboard.



## Activity 4 Visual Guide: Cardboard, Part 1 – Scoring



**THIRD**, while using your free hand to hold the cardboard in place, slide the cardboard cutter down the entire pencil line, continuing to push down gently to pierce the top layer.

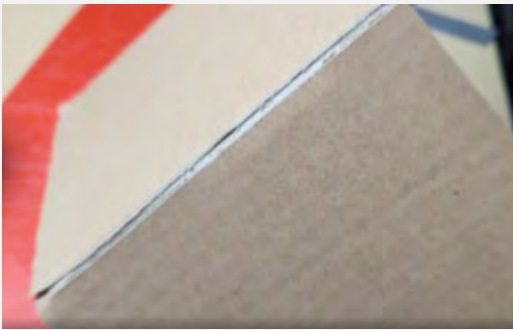

**FOURTH**, fold and snap the cardboard along the scored line.



**FIFTH**, use the ruler to draw a second line halfway between the left edge of the cardboard and your first scored line.



**SIXTH**, use the ruler to draw a third line halfway between the right edge of the cardboard and your first scored line.

## Activity 4 Visual Guide: Cardboard, Part 1 – Scoring



**SEVENTH**, score the first new line.



**EIGHTH**, snap the first new line.



**NINTH**, score the second new line.



**TENTH**, snap the second new line.

## Activity 4 Visual Guide: Cardboard, Part 1 – Scoring



**ELEVENTH**, connect the two ends of the cardboard.



**TWELFTH**, peel off a piece of tape about the same length as the cardboard.



**LAST**, place the tape along the connecting point of the two sides of the cardboard.



## Activity 4 Visual Guide: Cardboard, Part 2 – Cutting



**BEFORE YOU GET STARTED**, gather your supplies:

- › Protective gloves
- › A piece of cardboard
- › A cardboard cutter
- › A ruler
- › A pencil



**FIRST**, put on your gloves and then use the pencil and ruler to draw a straight line halfway across the cardboard.



**SECOND**, place the blade at the top of the line and press down so it pierces the top layer of cardboard.

## Activity 4 Visual Guide: Cardboard, Part 2 – Cutting



**THIRD**, snap the cardboard along the scored line.



**FOURTH**, stand the cardboard upright, place the cardboard cutter on the scored line, and begin to apply downward pressure.



**FIFTH**, saw the cardboard in two by pressing down on the cutter as you move it forward and back. Keep sawing until you reach the bottom.

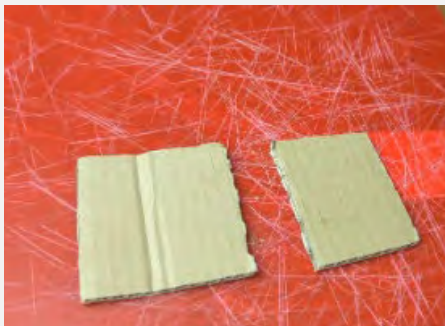

**LAST**, remove the cut piece of cardboard from the sheet. Congratulations! You cut a piece of cardboard.

## Activity 4 Visual Guide: Cardboard, Part 3 – Creating Curves



**FIRST**, use the pencil and ruler to draw a straight line halfway across the cardboard.

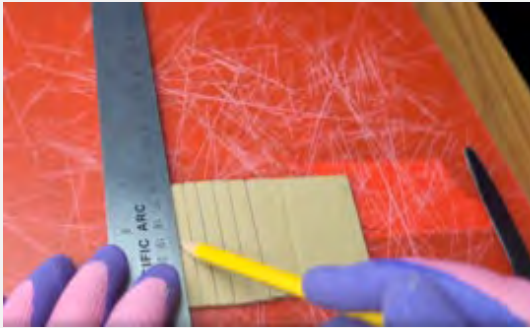

**SECOND**, use the pencil and ruler to draw multiple lines close to each other on both sides of the first line.



**THIRD**, score along all the drawn lines.

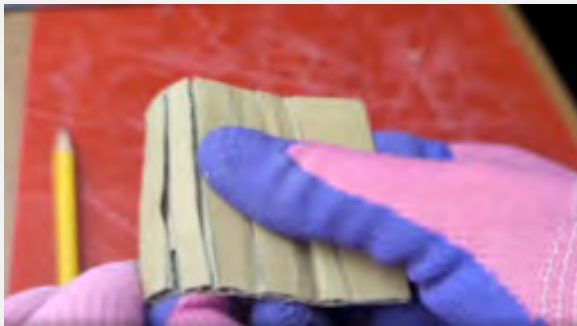

**FOURTH**, bend the cardboard along the scored lines. This will start to create a curve.

## Activity 4 Visual Guide: Cardboard, Part 3 – Creating Curves

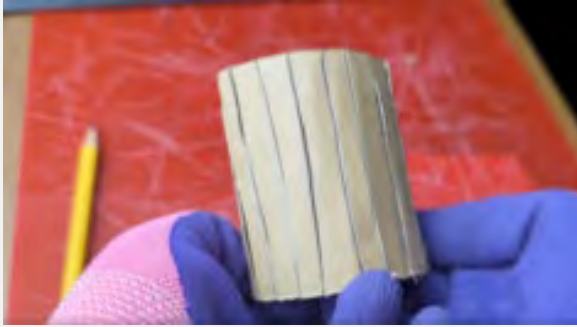

**LAST**, make sure all the scored lines are bent.

## Activity 4 Visual Guide: Cardboard, Part 4 – Creating Slots



**FIRST**, use your pencil to draw a narrow triangle centered at the top edge of the cardboard.



**SECOND**, stand the cardboard up and saw along one pencil line.



**THIRD**, saw back and forth along the other pencil line.



**FOURTH**, remove the triangle.

## Activity 4 Visual Guide: Cardboard, Part 4 – Creating Slots



**FIFTH**, create slots on your other pieces of cardboard, and connect the pieces by sliding slots into other slots.



**LAST**, experiment with connecting multiple pieces of cardboard.



## Activity 6 Visual Guide: Light-Up an LED (Square)

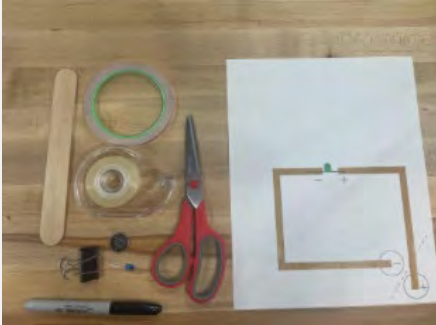

**BEFORE YOU GET STARTED**, gather your supplies:

- › 15" strip of copper tape
- › LED
- › Coin cell battery
- › Binder clip
- › Cellophane tape
- › Simple Circuit Template: Square
- › Popsicle stick



**FIRST**, pull the backing off a short strip of the copper tape.

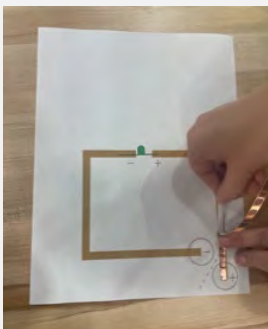

**SECOND**, place the edge of the tape at the start of the trace and slowly work your way up, using your finger or the edge of a Popsicle stick to push down the tape and make it smooth.

## Activity 6 Visual Guide: Light-Up an LED (Square)

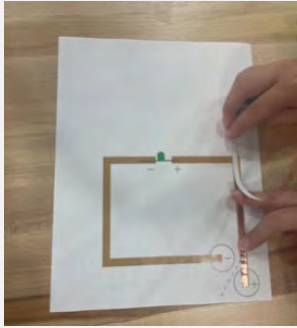

**THIRD**, remove the next small section of backing, then use your thumbnail to push down the tape and make it smooth.

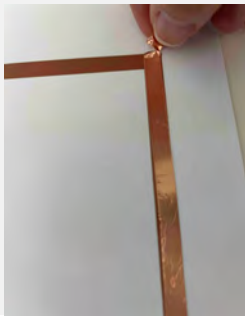

**FOURTH**, when you get to the end of a trace, rip the tape and overlap the start of a new piece on top of the strip you just finished.

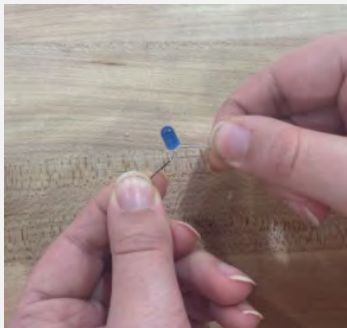

**FIFTH**, pull apart the leads of the LED.

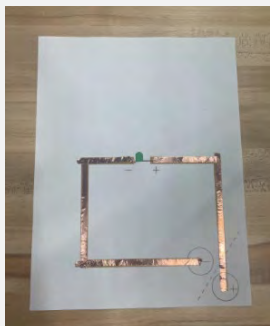

**SIXTH**, lay the LED on the copper tape and tape it down.



## Activity 6 Visual Guide: Light-Up an LED (Square)

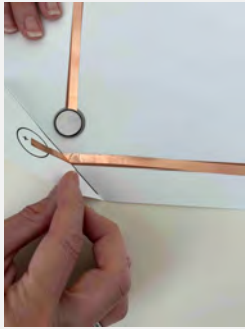

**SEVENTH**, place the battery on the designated area of the template and fold the corner over it.

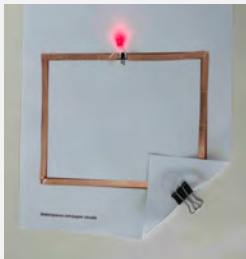

**LAST**, attach the binder clip to the folded corner.

## Activity 6 Visual Guide: Light-Up an LED (Straight Lines)

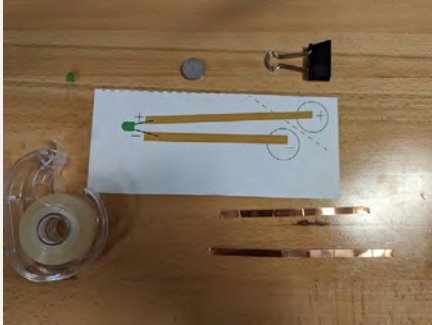

**BEFORE YOU GET STARTED**, gather your supplies:

- › Two strips of copper tape
- › LED
- › Coin cell battery
- › Binder clip
- › Cellophane tape
- › Simple Circuit Template: Straight Lines



**FIRST**, pull the backing off a short strip of the copper tape.

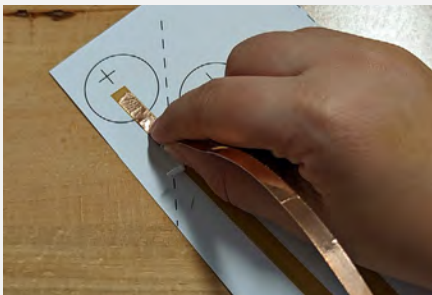

**SECOND**, place the edge of the tape at the start of the positive trace and slowly work your way up, using your finger to push down the tape and make it smooth.

## Activity 6 Visual Guide: Light-Up an LED (Straight Lines)

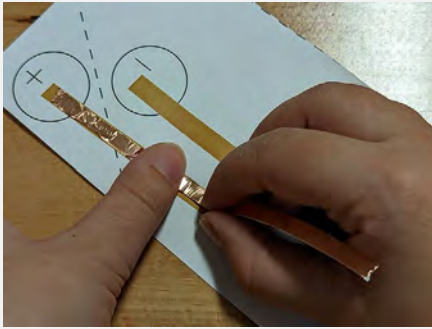

**THIRD**, remove the next small section of backing, then use your thumbnail to push down the tape and make it smooth.

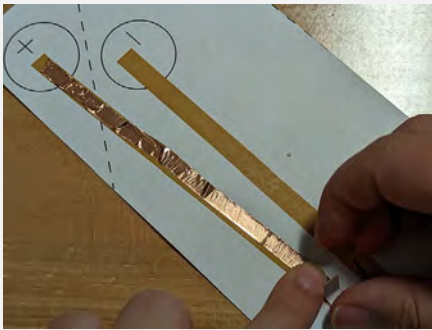

**FOURTH**, finish placing tape along the positive trace. Tear or cut the end of the tape if it is longer than the trace.

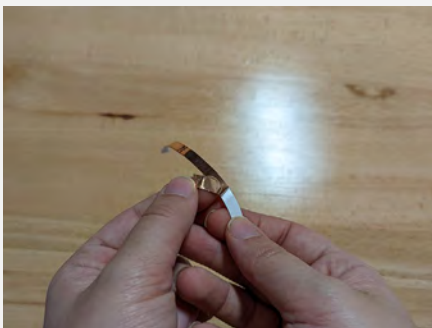

**FIFTH**, pull the backing off the other strip of the copper tape.

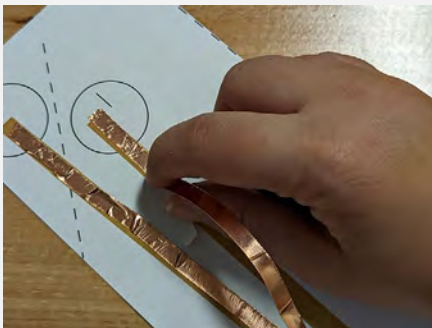

**SIXTH**, place the edge of the tape at the start of the negative trace and slowly work your way up, using your finger or the edge of a Popsicle stick to push down the tape and make it smooth.

## Activity 6 Visual Guide: Light-Up an LED (Straight Lines)

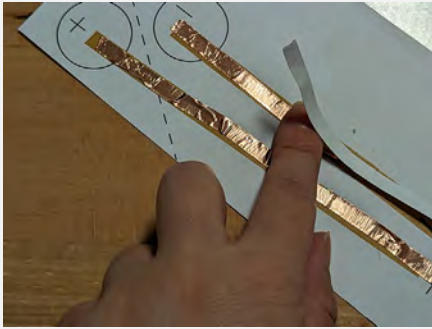

**SEVENTH**, remove the next small section of backing, then use your thumbnail to push down the tape and make it smooth.

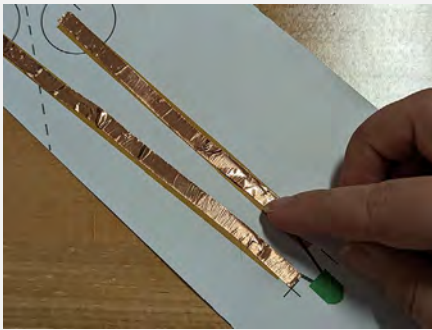

**EIGHTH**, finish placing tape along the negative trace. Tear or cut the end of the tape if it is longer than the trace.



**NINTH**, make sure your two pieces of copper tape stretch from inside the battery circles and cover the entire trace. The two pieces of tape should not be touching each other.

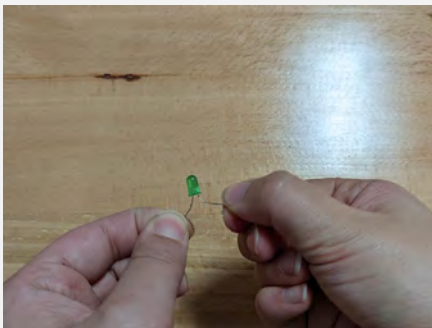

**TENTH**, pull apart the leads of the LED.

## Activity 6 Visual Guide: Light-Up an LED (Straight Lines)

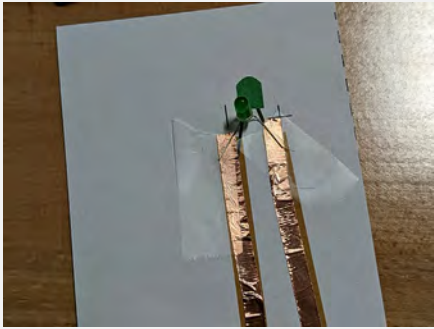

**ELEVENTH**, lay the LED on the copper tape and tape it down.

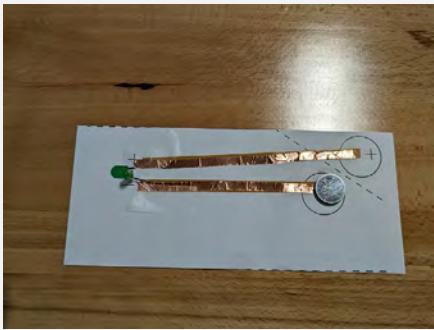

**TWELFTH**, place the battery on the designated area of the template. The positive side of the battery should be face up.

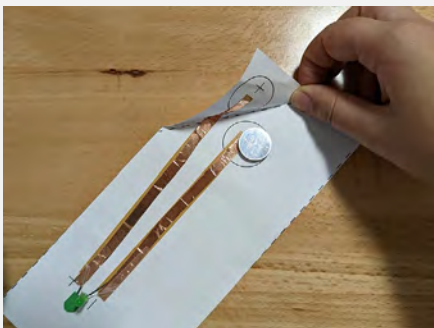

**THIRTEENTH**, fold the corner of the paper along the dashed line. When folded, the positive side of the battery will be touching the positive wire, completing the circuit.

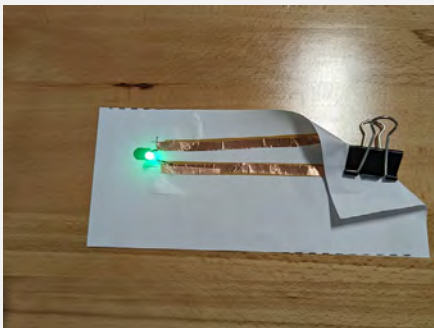

**LAST**, attach the binder clip to the folded corner.

## Activity 7 Visual Guide: Make a Light-up Sign

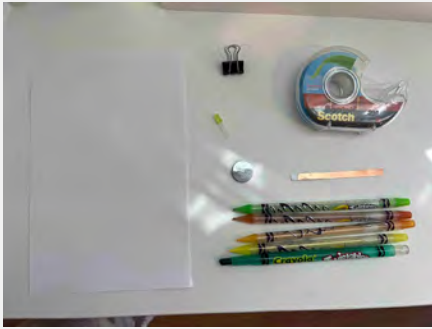

**BEFORE YOU GET STARTED**, gather your supplies:

- › Half sheet of printer paper
- › Binder clip
- › LED
- › Coin cell battery
- › Pencil
- › Colored pencils or markers
- › Copper tape
- › Cellophane tape
- › Optional: Popsicle stick



**FIRST**, fold your paper in half and draw your sign on the front, putting the part you want to light up near a corner.

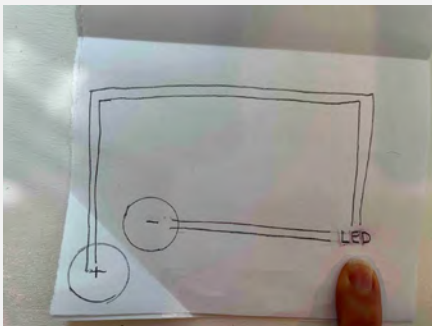

**SECOND**, draw the layout of the circuit, placing the battery in the opposite corner of where the LED will go. Mark the polarity of the battery.



## Activity 7 Visual Guide: Make a Light-up Sign

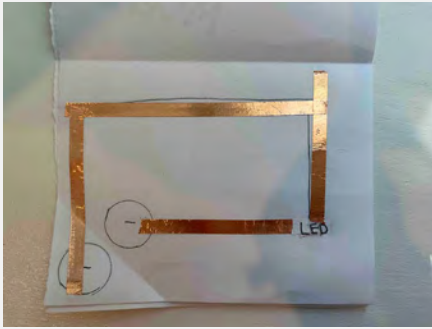

**THIRD**, lay the copper tape along the traces, removing small amounts of backing as you go. Smooth out any bumps with your finger (or the side of a Popsicle stick).

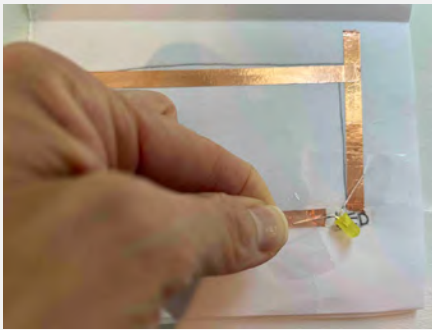

**FOURTH**, use cellophane tape to tape down the leads of the LED.

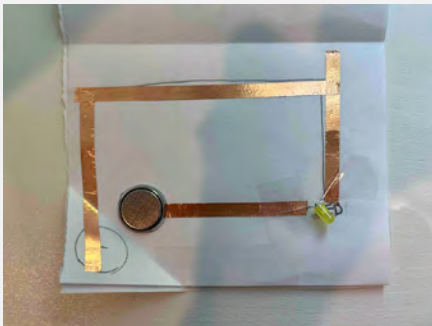

**FIFTH**, place your battery.

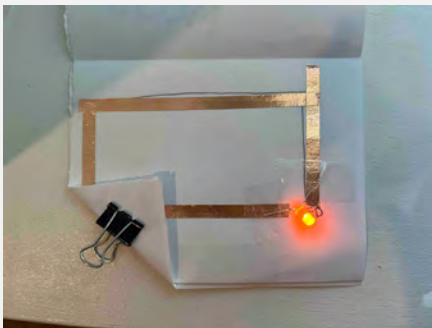

**SIXTH**, fold the corner of the paper over the battery and secure it with the binder clip. Test the circuit. Did your LED light up? If not, double-check that the polarities of the battery, LED, and copper tape match.

## Activity 7 Visual Guide: Make a Light-up Sign



**LAST**, close your sign and admire your finished product!



## Activity 8 Visual Guide: Make an Object Move



**BEFORE YOU GET STARTED**, gather:

- › A vibration motor
- › A battery
- › Tape
- › Scissors
- › Folded Paper Design

**NOTE:** If the ends of motor wires are not exposed, watch this 30-second [video](#) on how to strip wires with scissors.

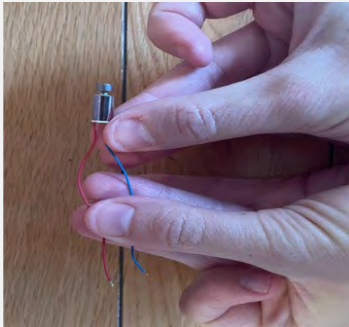

**FIRST**, pinch the exposed part of each stripped wire on a side of the battery. See if the motor begins to vibrate.



**SECOND**, use small pieces of tape to secure each wire on the sides of the battery.

## Activity 8 Visual Guide: Make an Object Move

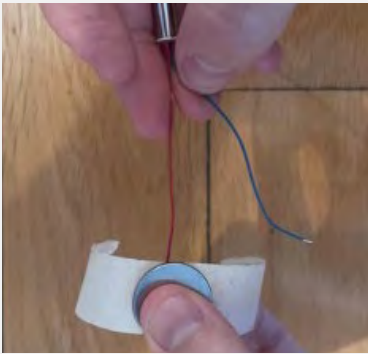

**THIRD**, place the battery on top of the red wire. Press down to secure it to the tape. It doesn't matter which side of the battery you use.

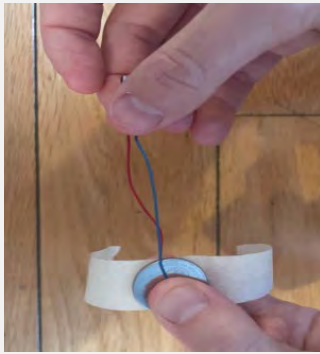

**FOURTH**, place the blue wire on top of the battery. Make sure the thin metal wire is touching the battery.

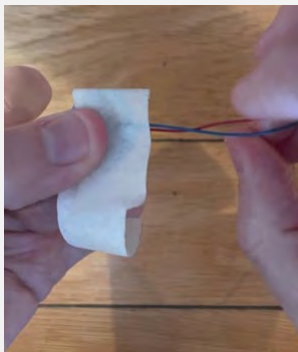

**FIFTH**, fold the tape over the battery. Squeeze to make sure the wires are as connected to the battery as possible. The motor should start vibrating. If it doesn't, remove the tape and try again!



**SIXTH**, make a face on a piece of paper and decide where you want to attach your motor. It's more fun if you try out multiple ways to attach it.

## Activity 8 Visual Guide: Make an Object Move

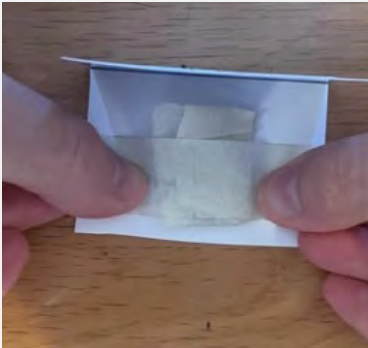

**SEVENTH**, use another piece of tape to secure the motor to the paper design. (It works better if you attach the battery.)

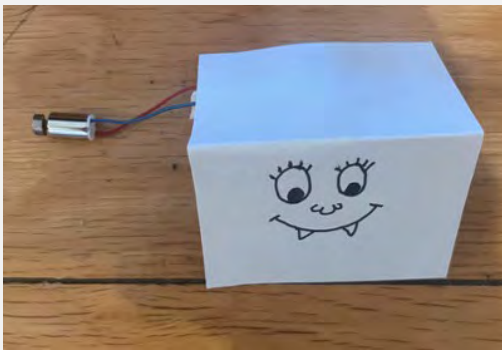

**LAST**, place your design upright and watch how it moves! Reposition the motor if you want to explore other forms of motion.

## Activity 9 Visual Guide, Make a Virtual Object: Part 1 – Stretching



**FIRST**, click the cube shape on the Basic Shapes list.

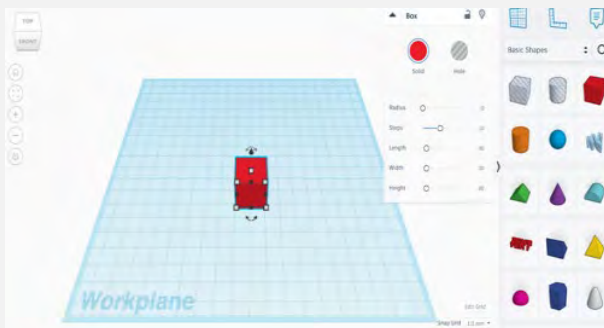

**SECOND**, move the cursor to the center of the blue workplane and click to place the cube.

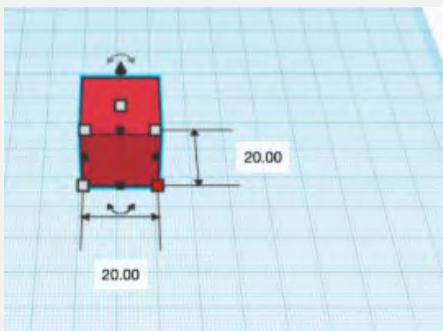

**THIRD**, click the tiny white square at the right side of the cube. It should turn red and show the dimensions of the cube in millimeters.

## Activity 9 Visual Guide, Make a Virtual Object: Part 1 – Stretching

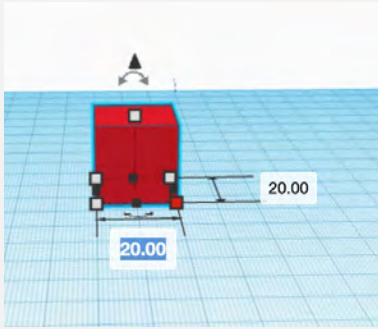

**FOURTH**, click on the box in the front center that says “20.00.” This box controls the width of the shape.

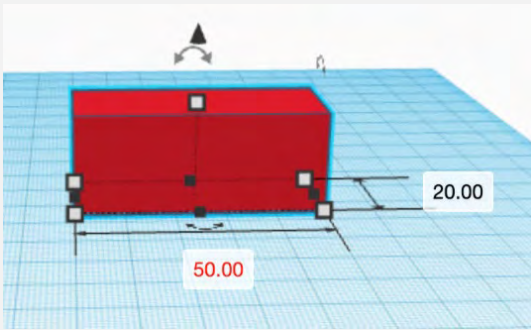

**FIFTH**, type 50.00 in the box and press “Enter.”

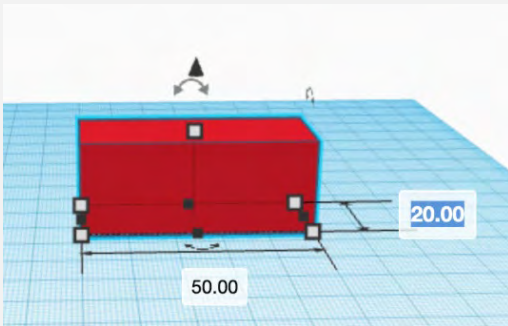

**SIXTH**, click on the box on the right side that says “20.00.” This box controls the length of the shape.

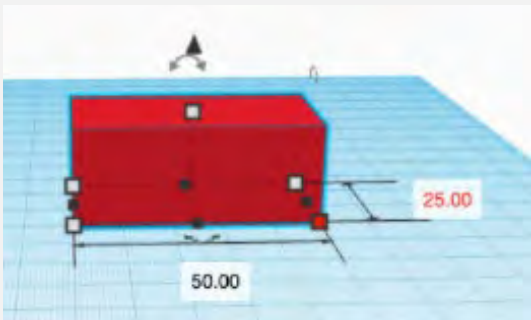

**SEVENTH**, type 25.00 in the box and press “Enter.”

## Activity 9 Visual Guide, Make a Virtual Object: Part 1 – Stretching

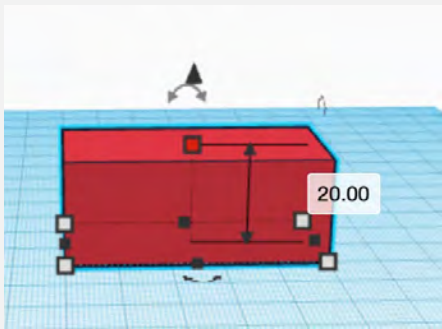

**EIGHTH**, click the white square on the top of the shape. It should turn red.

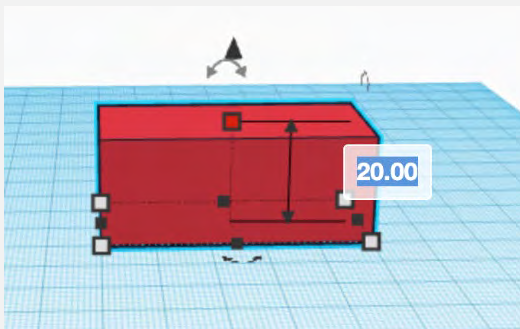

**NINTH**, click on the box on the front right side that says “20.00.” This box controls the height of the shape.

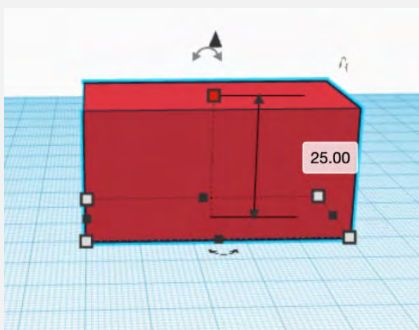

**LAST**, type 25.00 and press “Enter.”



## Activity 9 Visual Guide, Make a Virtual Object: Part 2 – Rotating

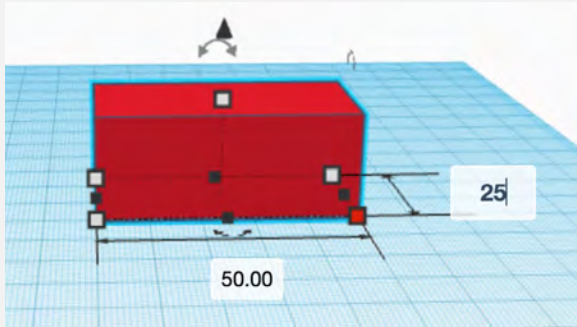

**FIRST**, click the white box in the right corner, making it turn red.

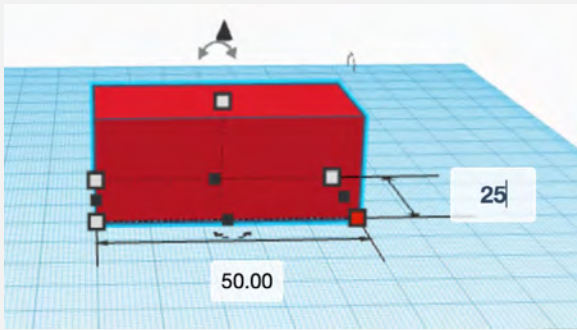

**SECOND**, notice the double-sided curved arrows that appear around the shape.

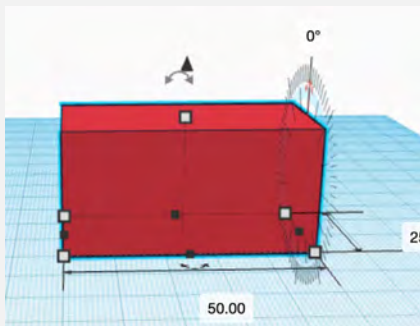

**THIRD**, hover the cursor over each curved arrow. This will show you the directions in which you can rotate the shape. There are three ways to rotate it!

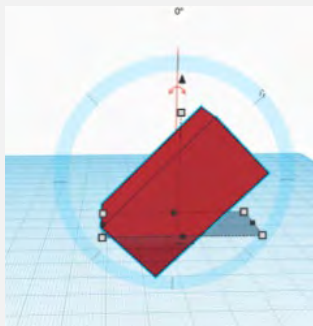

**FOURTH**, click on one of the rotation icons, and experiment with rotating the shape.

## Activity 9 Visual Guide, Make a Virtual Object: Part 2 – Rotating

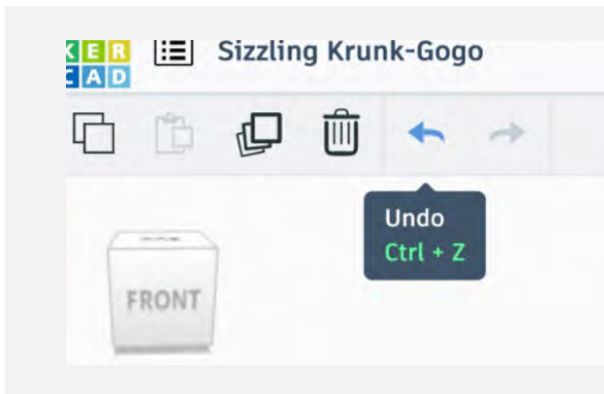

**LAST**, press the left-facing arrow at the top left of the build plate to undo any rotations and return the shape to its original position. You might need to press undo several times.



## Activity 9 Visual Guide, Make a Virtual Object: Part 3 – Creating Holes and Grouping

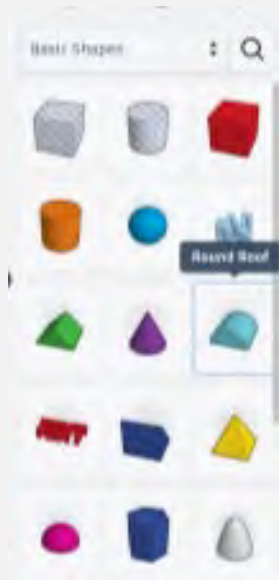

**FIRST**, select the Round Roof shape from the Basic Shapes list.

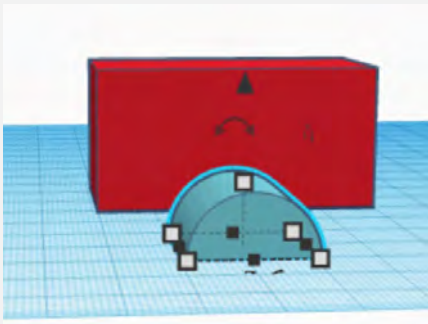

**SECOND**, place the Round Roof in front of the "red box."

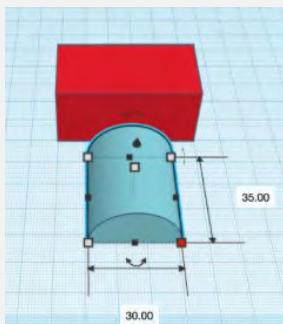

**THIRD**, set the width of the Round Roof to 30.00 and the length to 35.00.

## Activity 9 Visual Guide, Make a Virtual Object: Part 3 – Creating Holes and Grouping

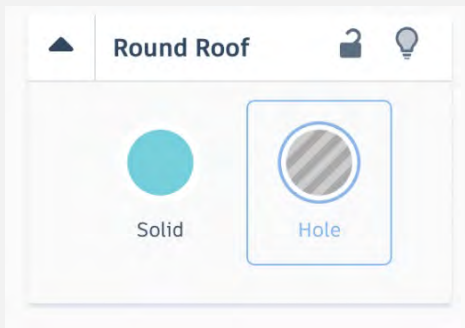

**FOURTH**, select the Hole icon. A shape can be a solid or a hole. A hole cuts shapes away from solids. The Round Roof will remove an arch shape from the red box, creating the bridge.

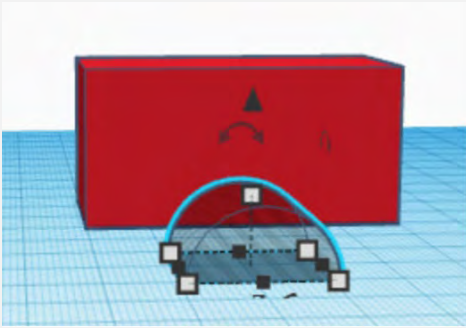

**FIFTH**, make sure the Round Roof turns transparent gray. Holes are transparent gray.



**SIXTH**, click the Top view on the view cube.

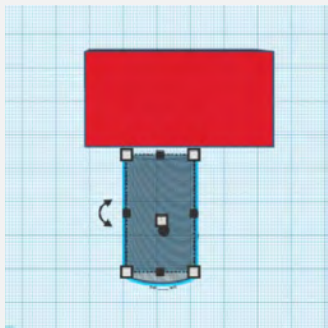

**SEVENTH**, make sure you have a bird's-eye view of your shapes.

## Activity 9 Visual Guide, Make a Virtual Object: Part 3 – Creating Holes and Grouping

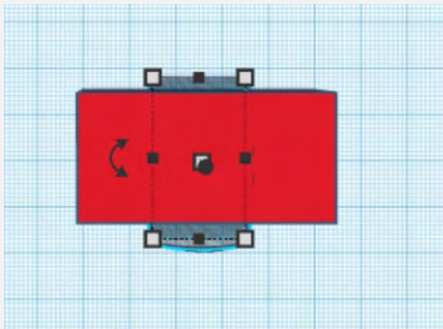

**EIGHTH**, use the arrows on your keyboard to move the hole so it is in the center of the red box. The hole should go all the way through the red box, creating a full bridge.

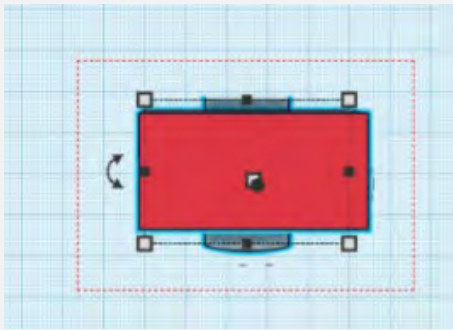

**NINTH**, click outside the shape and drag a bounding box around both shapes. This will select both shapes. Selected shapes are highlighted in blue.

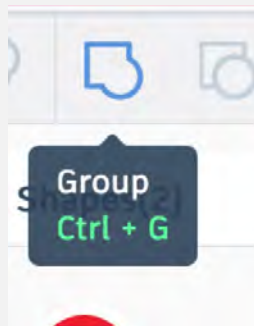

**TENTH**, click the Group icon. Group is how we combine shapes and create holes.

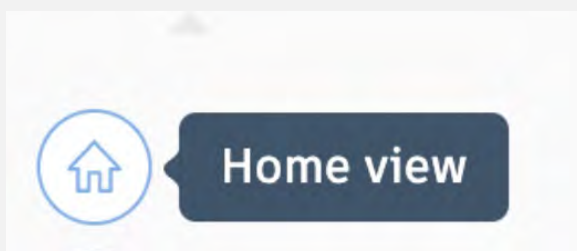

**LAST**, click Home view to reset the view.

## Activity 9 Visual Guide, Make a Virtual Object: Part 3 – Creating Holes and Grouping

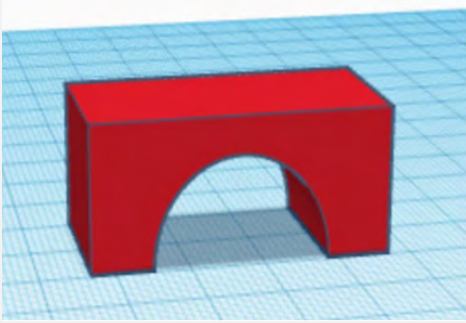

**CONGRATULATIONS!** You made a bridge block.

## Activity 9 Visual Guide, Make a Virtual Object: Part 4 – Lifting Shapes and Changing Colors



**FIRST**, select the Cylinder from the Basic Shapes list.

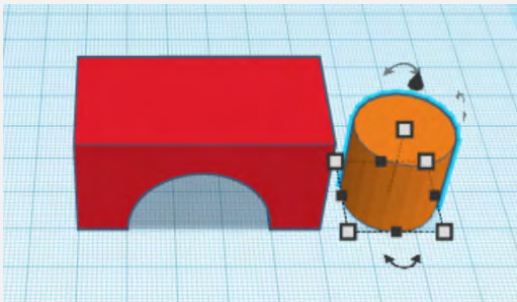

**SECOND**, place the Cylinder next to the bridge.



**THIRD**, select the Front view on the View Cube.

## Activity 9 Visual Guide, Make a Virtual Object: Part 4 – Lifting Shapes and Changing Colors

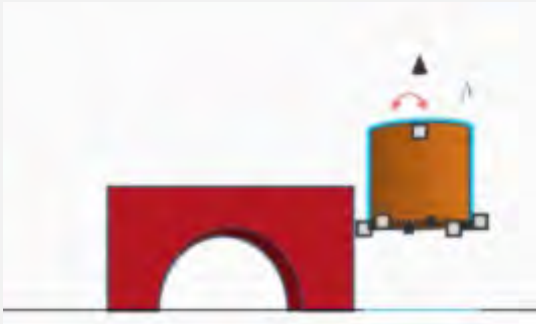

**FOURTH**, click on the cone shape above the Cylinder and drag it upward. This will lift the shape.



**FIFTH**, use the computer arrows to move the Cylinder to the left so it stacks on top of the bridge. Adjust the height of the lift as needed.

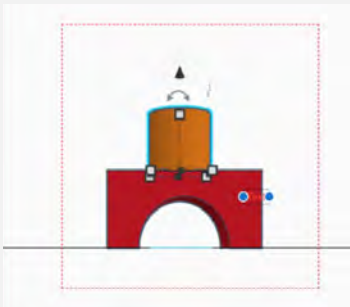

**SIXTH**, you will now group the shapes. Grouping lets us turn multiple shapes into one shape. Click outside the shapes and drag a bounding box around both shapes.

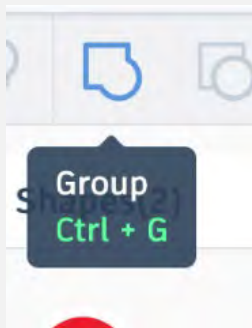

**SEVENTH**, select "Group" to combine the shapes.

## Activity 9 Visual Guide, Make a Virtual Object: Part 4 – Lifting Shapes and Changing Colors

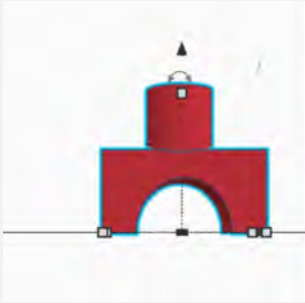

**EIGHTH**, you will now change the color!

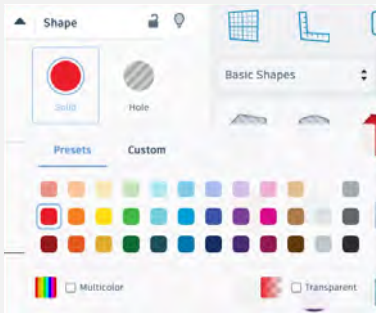

**LAST**, select "Solid," and then choose a color for your structure.

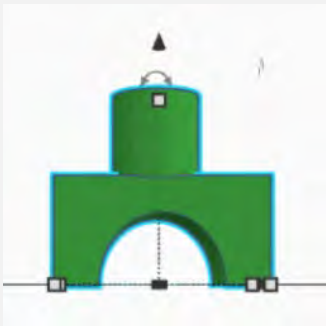

**CONGRATULATIONS!**

# Activity Primers



# WHAT'S NEXT IN MAKER CLUB?

**THE NEXT MAKER CLUB DATE IS:**

**IN THIS SESSION WE WILL:**

- › Begin brainstorming ideas for the model worlds we will make
- › Figure out what the world looks like, who lives there, and what we will build to make it
- › Do a maker project with paper

**THE SCHEDULE IS:**

- PART 1:** Welcome and Recap  
**PART 2:** Building a Paper World  
**PART 3:** Group World-Building Brainstorm  
**PART 4:** Individual World-Building Brainstorm  
**PART 5:** Reflect

**WE WILL USE THESE TOOLS AND MATERIALS:**



**Colorful Paper**



**Pencil**

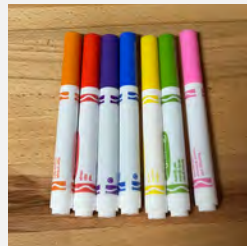

**Markers**











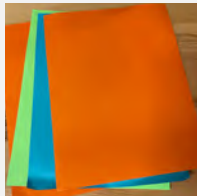







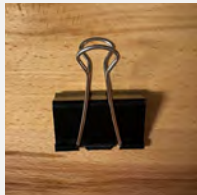

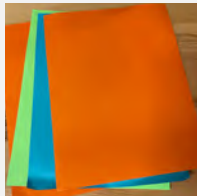







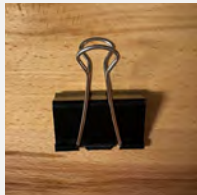

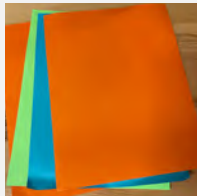

**Popsicle Stick**

**HEADS UP!**

- › The materials we will use might look different from the ones shown here.
- › This session requires some fine motor skills (writing, folding paper). Accommodations are available if needed.

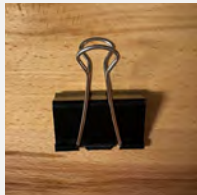
# WHAT'S NEXT IN MAKER CLUB?

<b>THE NEXT MAKER CLUB DATE IS:</b>																									
<b>IN THIS SESSION WE WILL:</b>	<ul style="list-style-type: none"><li>› Make journals so we have something to record our ideas for our worlds<ul style="list-style-type: none"><li>• Either: Use a hammer and nails to punch holes and then sew the pages together with a needle and thread, OR</li><li>• Wrap the journal binding with thread</li></ul></li><li>› Decorate our journals</li></ul>																								
<b>THE SCHEDULE IS:</b>	<p><b>PART 1:</b> Welcome and Recap <b>PART 2:</b> Taking a Closer Look <b>PART 3:</b> Make a Journal <b>PART 4:</b> Reflect</p>																								
<b>WE WILL USE THESE TOOLS AND MATERIALS:</b>	<table border="0"><tr><td data-bbox="548 1003 743 1197"></td><td data-bbox="776 1003 971 1197"></td><td data-bbox="1003 1003 1198 1197"></td><td data-bbox="1230 1003 1425 1197"></td></tr><tr><td data-bbox="548 1207 743 1281"><b>Paper and Cardstock</b></td><td data-bbox="776 1207 971 1281"><b>Popsicle Stick</b></td><td data-bbox="1003 1207 1198 1281"><b>Markers</b></td><td data-bbox="1230 1207 1425 1281"><b>Embroidery Needle</b></td></tr><tr><td data-bbox="548 1308 743 1501"></td><td data-bbox="776 1308 971 1501"></td><td data-bbox="1003 1308 1198 1501"></td><td data-bbox="1230 1308 1425 1501"></td></tr><tr><td data-bbox="548 1512 743 1585"><b>Embroidery Thread</b></td><td data-bbox="776 1512 971 1585"><b>Threader</b></td><td data-bbox="1003 1512 1198 1585"><b>Foam Block</b></td><td data-bbox="1230 1512 1425 1585"><b>Hammer</b></td></tr><tr><td data-bbox="548 1598 743 1791"></td><td data-bbox="776 1598 971 1791"></td><td></td><td></td></tr><tr><td data-bbox="548 1801 743 1869"><b>Binder Clips</b></td><td data-bbox="776 1801 971 1869"><b>Nails</b></td><td></td><td></td></tr></table>					<b>Paper and Cardstock</b>	<b>Popsicle Stick</b>	<b>Markers</b>	<b>Embroidery Needle</b>					<b>Embroidery Thread</b>	<b>Threader</b>	<b>Foam Block</b>	<b>Hammer</b>					<b>Binder Clips</b>	<b>Nails</b>		
																									
<b>Paper and Cardstock</b>	<b>Popsicle Stick</b>	<b>Markers</b>	<b>Embroidery Needle</b>																						
																									
<b>Embroidery Thread</b>	<b>Threader</b>	<b>Foam Block</b>	<b>Hammer</b>																						
																									
<b>Binder Clips</b>	<b>Nails</b>																								

## HEADS UP!

- › The materials we will use might look different from the ones shown here.
- › This session requires some fine motor skills (sewing, tying knots). Help is available if needed.
- › Hammering might be loud. We have protective headphones available.
- › Embroidery needles are blunt, not sharp.

# WHAT'S NEXT IN MAKER CLUB?

**THE NEXT MAKER CLUB DATE IS:**

**IN THIS SESSION WE WILL:**

- › Play around with clay
- › Figure out what objects, shapes, and textures can be made out of clay
- › Learn clay-shaping techniques and how to use clay-sculpting tools

**THE SCHEDULE IS:**

- PART 1:** Welcome and Recap  
**PART 2:** Clay Exploration  
**PART 3:** Clay-Shaping Techniques  
**PART 4:** Create a Character  
**PART 5:** Reflect

**WE WILL USE THESE TOOLS AND MATERIALS:**



**Air-Dry Clay**



**Clay-Sculpting Tools**

**HEADS UP!**

- › The materials we will use might look different from the ones shown here.
- › Clay might make your hands sticky. Hand wipes will be available.

# WHAT'S NEXT IN MAKER CLUB?

**THE NEXT MAKER CLUB DATE IS:**

**IN THIS SESSION WE WILL:**

- › Learn how to use a cardboard-cutting tool called a *canary cutter*.
- › Use the canary cutter to practice four cardboard construction techniques: scoring, cutting, creating curves, and creating slots

**THE SCHEDULE IS:**

- PART 1:** Welcome and Recap  
**PART 2:** Cardboard Introduction and Exploration  
**PART 3:** Cardboard Construction Techniques  
**PART 4:** Sketch Your Ideas  
**PART 5:** Reflect

**WE WILL USE THESE TOOLS AND MATERIALS:**



**Cardboard**



**Canary Cutter**



**Ruler**



**Cardboard Scissors**

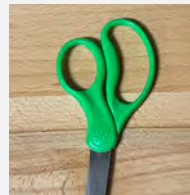

**Scissors**

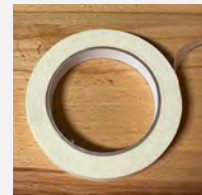

**Masking Tape**

**HEADS UP!**

- › The materials we will use might look different from the ones shown here.
- › This session might get loud from the noise of the cardboard cutters. We have protective headphones available.
- › Cardboard cutters can be sharp. We will use safety gloves.

# WHAT'S NEXT IN MAKER CLUB?

**THE NEXT MAKER CLUB DATE IS:**

**IN THIS SESSION WE WILL:**

- › Use hot glue guns to create sculptures with blocks
- › Create *diagrams* (labeled drawings) of our structures

**THE SCHEDULE IS:**

- PART 1:** Welcome and Recap
- PART 2:** Exploring Blocks
- PART 3:** Hot Glue Gun (or Glue Dots) Overview
- PART 4:** Block Sculptures
- PART 5:** Diagramming
- PART 6:** Reflect

**WE WILL USE THESE TOOLS AND MATERIALS:**



**Foam Blocks**



**Hot Glue Gun**



**Ruler**













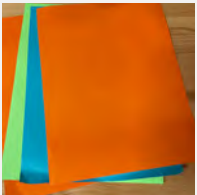







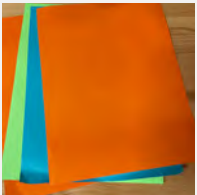



**Hot Glue Sticks**

**HEADS UP!**

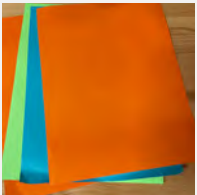
- › The materials we will use might look different from the ones shown here.
- › Hot glue gets hot. We will only touch the handle of the hot glue gun and keep our fingers away from the hot glue as it dries.

# WHAT'S NEXT IN MAKER CLUB?

<b>THE NEXT MAKER CLUB DATE IS:</b>																	
<b>IN THIS SESSION WE WILL:</b>	<ul style="list-style-type: none"><li>➤ Explore simple circuits and how they work</li><li>➤ Learn how to use a battery and copper tape to make an LED light up</li></ul>																
<b>THE SCHEDULE IS:</b>	<p><b>PART 1:</b> Welcome and Recap</p> <p><b>PART 2:</b> Inspiration</p> <p><b>PART 3:</b> How Does a Circuit Work?</p> <p><b>PART 4:</b> Try It!</p> <p><b>PART 5:</b> Reflect</p>																
<b>WE WILL USE THESE TOOLS AND MATERIALS:</b>	<table border="0"><tr><td data-bbox="548 938 743 1131"></td><td data-bbox="776 938 971 1131"></td><td data-bbox="1003 938 1198 1131"></td><td data-bbox="1230 938 1425 1131"></td></tr><tr><td data-bbox="613 1144 678 1176"><b>LEDs</b></td><td data-bbox="784 1144 963 1176"><b>Copper Tape</b></td><td data-bbox="1036 1144 1166 1218"><b>Coin Cell Battery</b></td><td data-bbox="1222 1144 1433 1176"><b>Colorful Paper</b></td></tr><tr><td data-bbox="548 1241 743 1434"></td><td data-bbox="776 1241 971 1434"></td><td data-bbox="1003 1241 1198 1434"></td><td data-bbox="1230 1241 1425 1434"></td></tr><tr><td data-bbox="565 1446 727 1520"><b>Cellophane Tape</b></td><td data-bbox="792 1446 954 1478"><b>Binder Clip</b></td><td data-bbox="1003 1446 1198 1478"><b>Popsicle Stick</b></td><td data-bbox="1271 1446 1385 1478"><b>Scissors</b></td></tr></table>					<b>LEDs</b>	<b>Copper Tape</b>	<b>Coin Cell Battery</b>	<b>Colorful Paper</b>					<b>Cellophane Tape</b>	<b>Binder Clip</b>	<b>Popsicle Stick</b>	<b>Scissors</b>
																	
<b>LEDs</b>	<b>Copper Tape</b>	<b>Coin Cell Battery</b>	<b>Colorful Paper</b>														
																	
<b>Cellophane Tape</b>	<b>Binder Clip</b>	<b>Popsicle Stick</b>	<b>Scissors</b>														
<b>HEADS UP!</b>	<ul style="list-style-type: none"><li>➤ The materials we will use might look different from the ones shown here.</li><li>➤ This activity uses tiny pieces. If you have a hard time using small pieces or tools, help is available.</li></ul>																



# WHAT'S NEXT IN MAKER CLUB?

**THE NEXT MAKER CLUB DATE IS:**

**IN THIS SESSION WE WILL:**

Use what we learned about circuits in Activity 6 to design a light-up sign for our worlds

**THE SCHEDULE IS:**

- PART 1:** Welcome and Recap
- PART 2:** What Makes a Title Memorable?
- PART 3:** Whole-Class Sign Design
- PART 4:** Individual Sign Design
- PART 5:** Reflect

**WE WILL USE THESE TOOLS AND MATERIALS:**

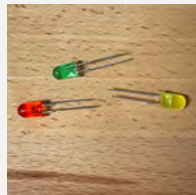

**LEDs**

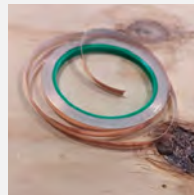

**Copper Tape**



**Coin Cell Battery**



**Paper**



**Cellophane Tape**

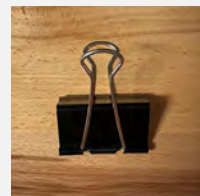

**Binder Clip**



**Popsicle Stick**

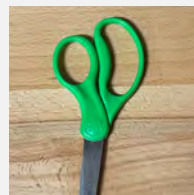

**Scissors**

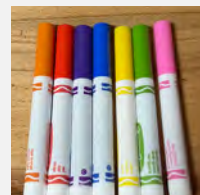









**Markers**

**HEADS UP!**

- The materials we will use might look different from the ones shown here.
- This activity uses tiny pieces. If you have a hard time using small pieces or tools, help is available.



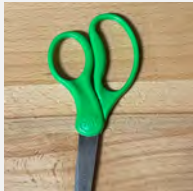

















# WHAT'S NEXT IN MAKER CLUB?

<b>THE NEXT MAKER CLUB DATE IS:</b>	
<b>IN THIS SESSION WE WILL:</b>	Explore how batteries and motors can be used to make objects that move or have moving parts
<b>THE SCHEDULE IS:</b>	<b>PART 1:</b> Welcome and Recap <b>PART 2:</b> Circuits and Motors <b>PART 3:</b> Try It! <b>PART 4:</b> Reflect
<b>WE WILL USE THESE TOOLS AND MATERIALS:</b>	<div data-bbox="586 821 777 1010"></div> <p data-bbox="570 1024 797 1056"><b>Vibration Motor</b></p> <div data-bbox="888 821 1079 1010"></div> <p data-bbox="855 1024 1112 1056"><b>Cylindrical Battery</b></p> <div data-bbox="1190 821 1382 1010"></div> <p data-bbox="1170 1024 1401 1056"><b>Coin Cell Battery</b></p> <div data-bbox="586 1079 777 1268"></div> <p data-bbox="586 1283 777 1314"><b>Masking Tape</b></p> <div data-bbox="888 1079 1079 1268"></div> <p data-bbox="888 1283 1079 1314"><b>Hot Glue Gun</b></p> <div data-bbox="1190 1079 1382 1268"></div> <p data-bbox="1179 1283 1393 1314"><b>Hot Glue Sticks</b></p> <div data-bbox="586 1346 777 1535"></div> <p data-bbox="626 1549 737 1581"><b>Scissors</b></p> <div data-bbox="888 1346 1079 1535"></div> <p data-bbox="927 1549 1040 1581"><b>Markers</b></p>
<b>HEADS UP!</b>	<ul style="list-style-type: none"><li>➤ The materials we will use might look different from the ones shown here.</li><li>➤ This activity uses tiny pieces. If you have a hard time using small pieces or tools, help is available.</li></ul>

# WHAT'S NEXT IN MAKER CLUB?

<b>THE NEXT MAKER CLUB DATE IS:</b>	
<b>IN THIS SESSION WE WILL:</b>	Make a digital version of our block sculptures using a 3D modeling software called Tinkercad
<b>THE SCHEDULE IS:</b>	<b>PART 1:</b> Welcome and Recap <b>PART 2:</b> Logging In to Tinkercad <b>PART 3:</b> Playing with Tinkercad <b>PART 4:</b> Learning Techniques <b>PART 5:</b> Reflect
<b>WE WILL USE THESE TOOLS AND MATERIALS:</b>	 <p><b>Laptop or Tablet</b></p>
<b>HEADS UP!</b>	<ul style="list-style-type: none"><li>› We may use more than just a laptop or tablet.</li><li>› The materials we will use might look different from the ones shown here.</li></ul>

# WHAT'S NEXT IN MAKER CLUB?

<b>THE NEXT MAKER CLUB DATE IS:</b>													
<b>IN THIS SESSION WE WILL:</b>	<ul style="list-style-type: none"><li>› Inventory the items we have made for our worlds</li><li>› Select which items to include in our worlds</li><li>› Determine if any items should be refined</li><li>› Decide what additional items to include in our worlds</li><li>› Get to work!</li></ul>												
<b>THE SCHEDULE IS:</b>	<p><b>PART 1:</b> Welcome and Recap</p> <p><b>PART 2:</b> Inventory and Planning</p> <p><b>PART 3:</b> Build On!</p> <p><b>PART 4:</b> Reflect</p> <p><b>PART 5:</b> Preview the Showcase</p>												
<b>WE WILL USE THESE TOOLS AND MATERIALS:</b>	<table border="0"><tr><td data-bbox="565 1024 803 1213"></td><td data-bbox="865 1024 1104 1213"></td><td data-bbox="1161 1024 1409 1213"></td></tr><tr><td data-bbox="609 1228 760 1260"><b>Cardboard</b></td><td data-bbox="889 1228 1084 1260"><b>Canary Cutter</b></td><td data-bbox="1250 1228 1323 1260"><b>Ruler</b></td></tr><tr><td data-bbox="560 1327 808 1516"></td><td data-bbox="893 1327 1079 1516"></td><td data-bbox="1190 1327 1383 1516"></td></tr><tr><td data-bbox="548 1533 820 1564"><b>Cardboard Scissors</b></td><td data-bbox="925 1533 1047 1564"><b>Scissors</b></td><td data-bbox="1193 1533 1383 1564"><b>Masking Tape</b></td></tr></table>				<b>Cardboard</b>	<b>Canary Cutter</b>	<b>Ruler</b>				<b>Cardboard Scissors</b>	<b>Scissors</b>	<b>Masking Tape</b>
													
<b>Cardboard</b>	<b>Canary Cutter</b>	<b>Ruler</b>											
													
<b>Cardboard Scissors</b>	<b>Scissors</b>	<b>Masking Tape</b>											

## HEADS UP!

- › You'll be able to use any tools that you need, even if they aren't pictured.
- › The tools and materials we will use might look different from the from the ones shown here.
- › This session might get loud from cutting tools. We have protective headphones available.
- › Cardboard cutters can be sharp! We will use safety gloves.

# Other Documents

**Activity 1: World Inventory Chart**

Your Name:

World Type:

LIVING	NON-LIVING

## Activity 6: Circuit Template (Square)

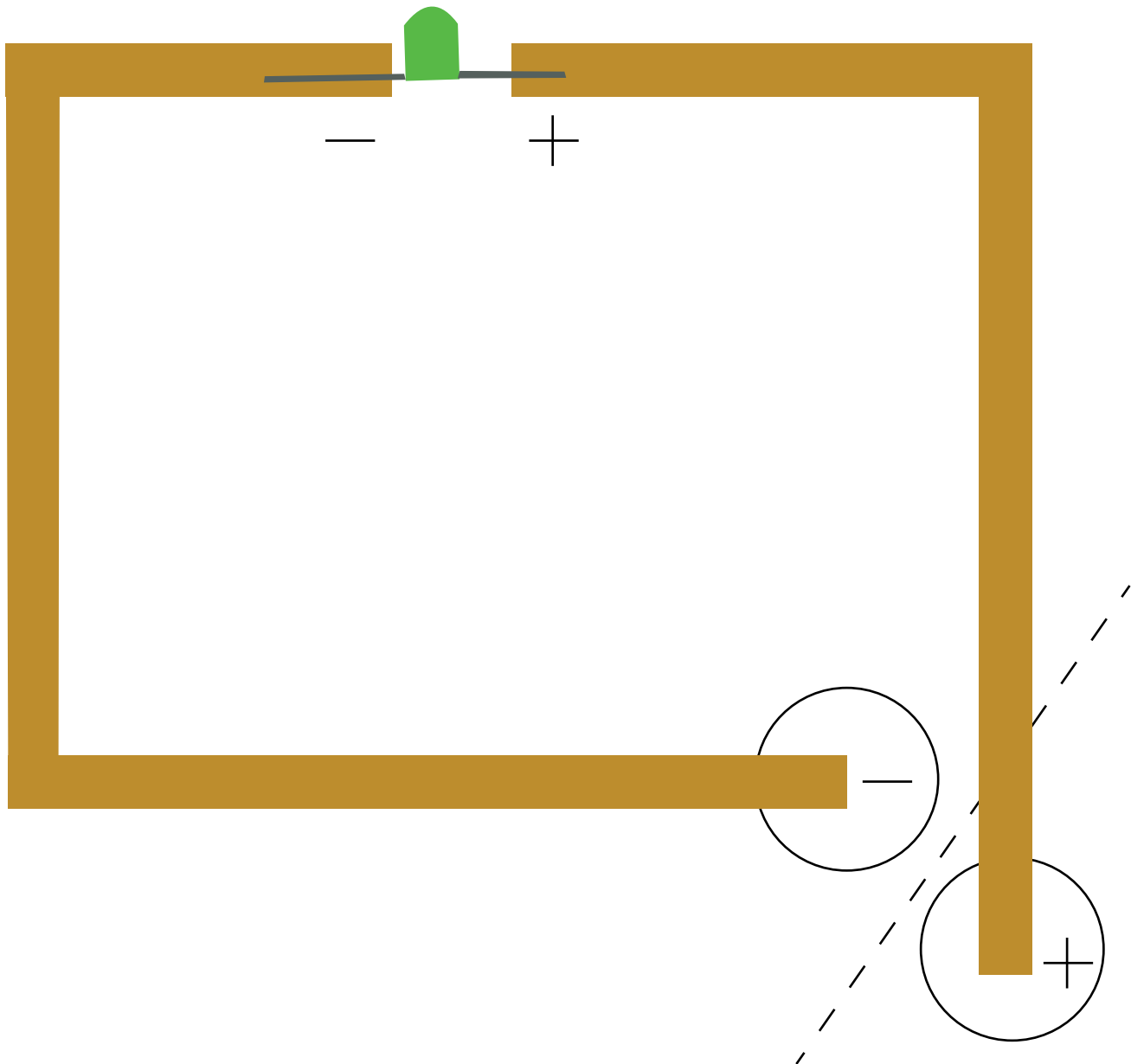

# Activity 6: Circuit Template (Straight Lines)

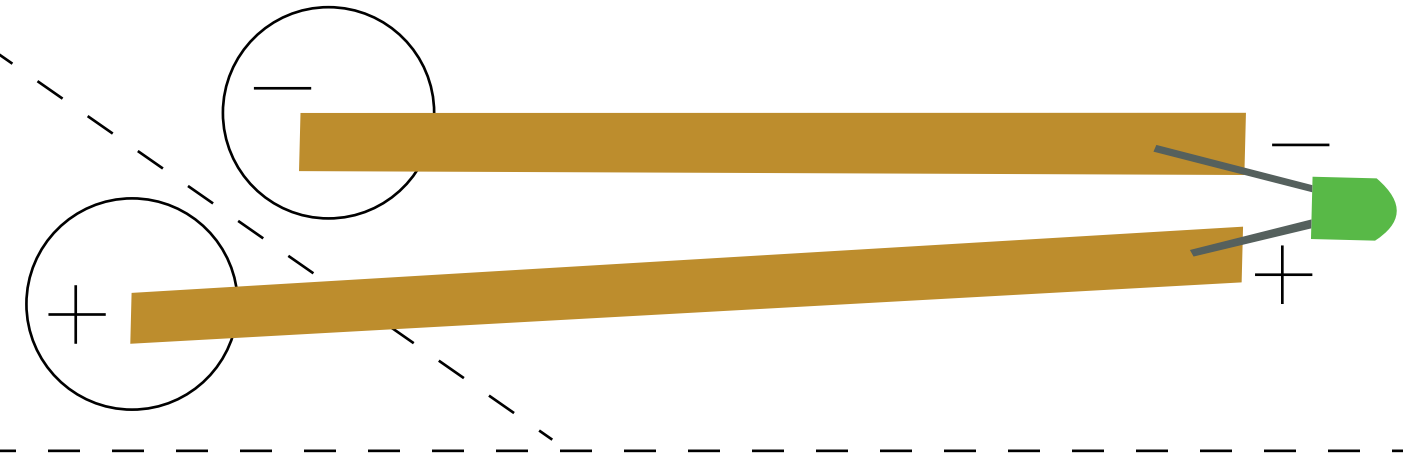
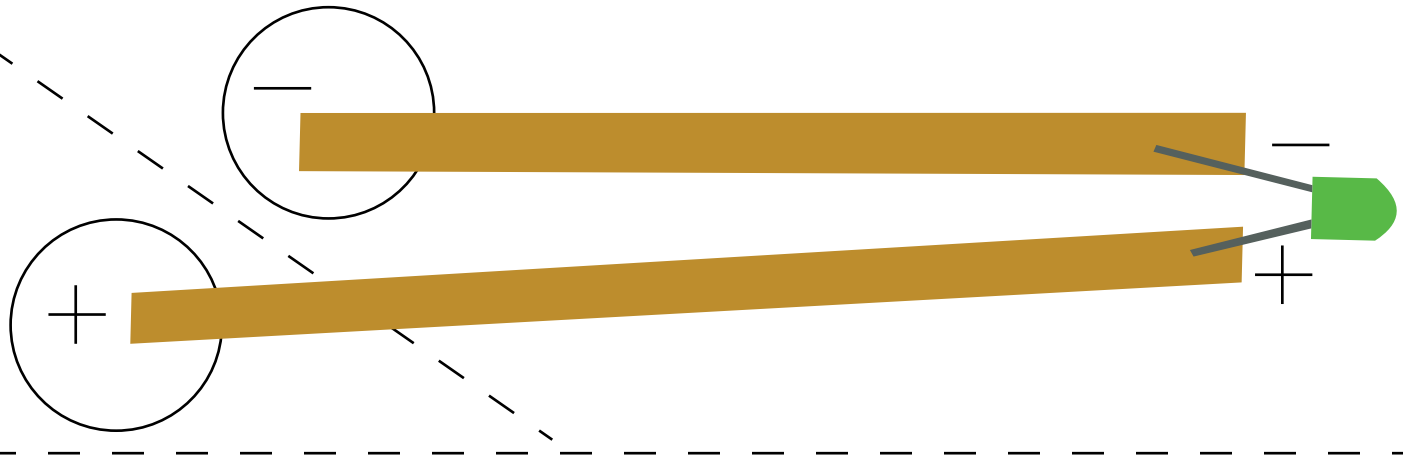



# Activity 7: Parallel Circuit Template

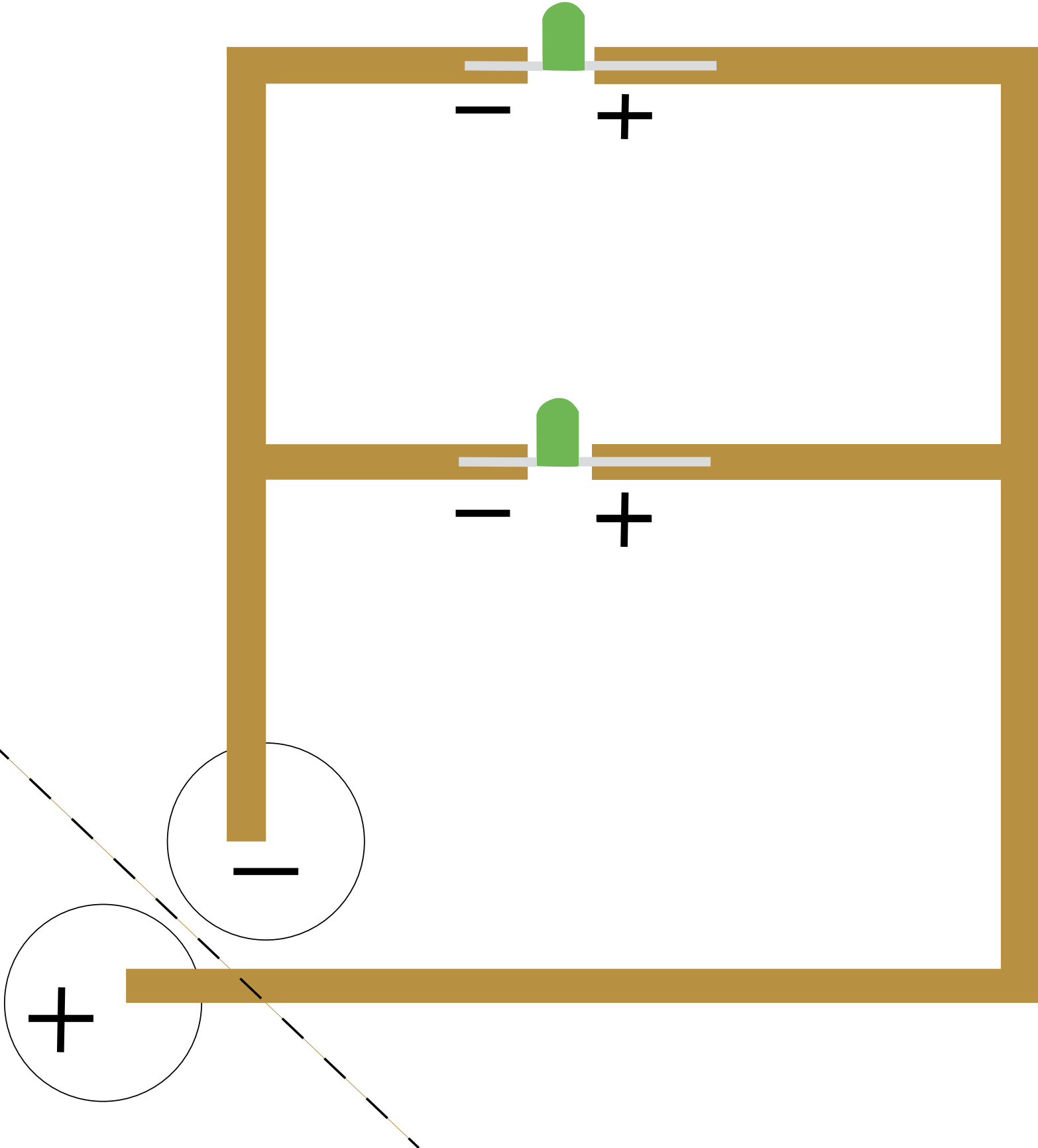

## Activity 10: Final Inventory and Planning Sheet

### READY

OBJECTS
1.
2.
3.
4.

### FIX, CHANGE, OR IMPROVE

OBJECT	CHANGES TO MAKE	MATERIALS NEEDED

### NEW THINGS TO MAKE

OBJECT	MATERIALS NEEDED

## Engineering Design Process Graphic

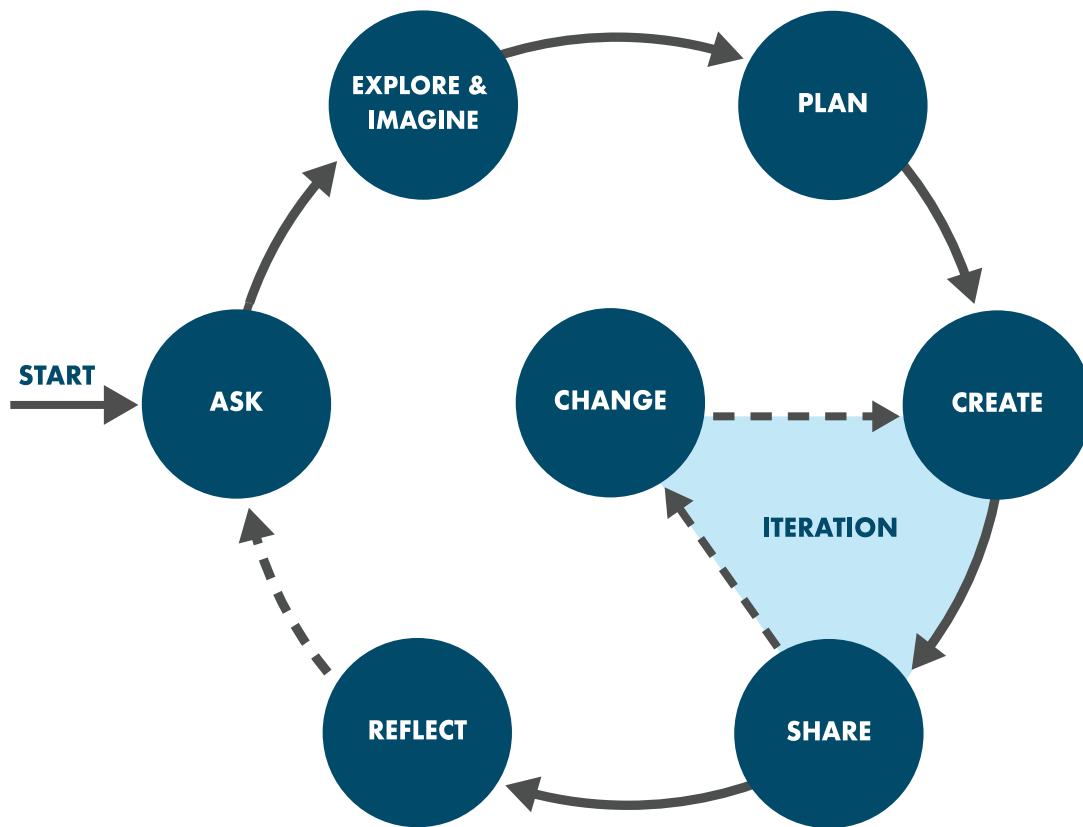

## I Made It! Maker Badge

